



Catalogo 2025

LINEA CLASS

2025

.01



Catalogo
CLASS

Tecnologia
di stampaggio
rotazionale

Rotational
molding
technology

.02



Catalogo
FLOW

Tecnologia
di stampaggio
ad iniezione

Injection
molding
technology

.03

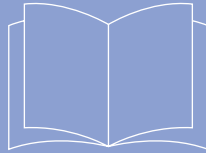

Listino
prezzi

Class,
Flow,
Esplorando

Class,
Flow,
Esplorando

Index

0 INDICE PER COLLEZIONE

INDEX BY COLLECTION

p. 4

1 INTRODUZIONE

INTRODUCTION

Azienda Company p. 8

Sostenibilità Sustainability p. 10

Tecnologia Technology p. 14

Vasar Vasar p. 18

2 PRODOTTI

PRODUCTS

Intrecci tattili Touch-sensitive twists

Shabby p. 24

Bambù p. 38

Bouclé p. 42

Trame p. 48

Sussurri marini Sea waves whispers

Bali p. 56

Tenui atmosfere Warm atmospheres

Gaudi p. 64

Bubble p. 68

Acaya p. 72

Frammenti urbani Urban fragments

Ardesia p. 78

City p. 84

Linea p. 90

Pura essenza Purest essence

Quadra p. 96

Tonda p. 108

Leviga p. 114

Crespia p. 120

Radici mediterranee Mediterranean roots

Lombardia p. 128

Country p. 132

Impero p. 136

Sfumature classiche Classical nuances

Agrigento p. 144

Classico impruneta p. 148

Nastro p. 152

3 OVERVIEW

OVERVIEW

Overview per tipologia Overview by type p. 158

Colori e texture Colors and textures p. 162

Legenda icone Icons legend p. 164

Shabby



CORI
Conchino
p. 26



CMHA
Campana
p. 24



CTFS
Ciotola
p. 27



SFRI
Sfera
p. 24



TBRI
Tronco conico
p. 25



TCRI PV
Portavaso
p. 25



COSY PV
Portavaso
p. 31



PIL PV
Portavaso quadro
p. 25

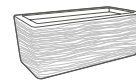

CATRI
Cassetta
p. 31



BASY
Cassetta
p. 31



CASR PV
Cassetta alta
p. 31

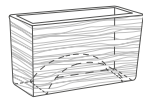

CATLR
Cassetta alta
p. 31

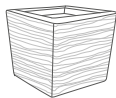

CUBRI
Cubo
p. 25



ACASHAB
Vaso urbano
p. 33



GERSY
Gerla a muro
p. 29



VPBSH
Vaso pensile
p. 29



RAIN
**Serbatoio acqua
piovana**
p. 28

Bambù



CONCAN
Conchino
p. 38

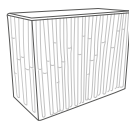

CANTL
Cassetta alta
p. 38

Bouclé



CILBOU
Cilindro
p. 42

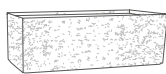

CASBOU
Cassetta
p. 46

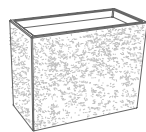

CASHBOU
Cassetta alta
p. 46

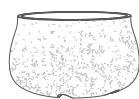

ACABOU
Vaso urbano
p. 46

Trame



SACCO
Cilindro
p. 48



TICIL
Cilindro
p. 48

Bali



CONCORD
Conchino
p. 56

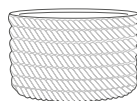

CILCORD
Cilindro
p. 59



CIOCORD
Ciotola
p. 56

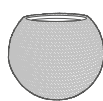

SFERCORD
Sfera
p. 59

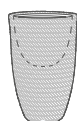

BOMCORD
Portavaso
p. 56

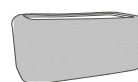

CASCORD
Cassetta
p. 59



ACACORD
Vaso urbano
p. 57

Gaudi



CTGU
Conchino
p. 64



VSGU 45
Cachepot
p. 64



VSGU 55
Cachepot
p. 64



CSGU
Cassetta ovale
p. 65

Bubble



BCA
Conchino
p. 68



BCI
Conchino
p. 68



BFU PV
Portvaso
p. 68

Acaya



ACAYA
Acaya
p. 73

Ardesia



CILAR
Cilindro
p. 78



CILAR PV
Portvaso
p. 80



CUBLA PV
Portvaso quadro
p. 79



CATLA
Cassetta
p. 78

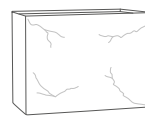

CATLH
Cassetta alta
p. 78



CUBLA
Cubo
p. 79

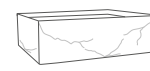

CUBLA B
Cubo
p. 79

City



CLRG
Cilindro
p. 84



CLRG PV
Portvaso
p. 85



CURG PV
Portvaso quadro
p. 84



CSRG
Cassetta
p. 87

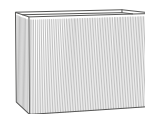

CSRGH
Cassetta alta
p. 87

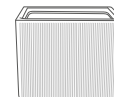

CURG
Cubo
p. 87

Linea

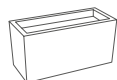

CASLINEA
Cassetta
p. 90

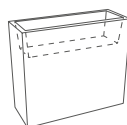

CASLINEA PV
Cassetta alta
p. 90

Quadra



PRICO
Tronco conico
p. 100

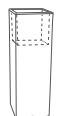

LTR PV
Portavaso quadro
p. 97

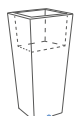

QNS PV
Portavaso quadro
p. 101

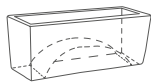

CATL XL
Cassetta
p. 99

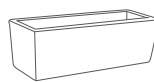

CATL B
Cassetta
p. 97

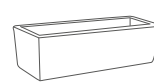

BATL
Cassetta
p. 99

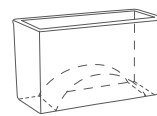

CATL
Cassetta alta
p. 97

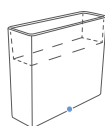

CSTS PV
Cassetta alta
p. 103



VNS PV
Cassetta alta
p. 103

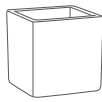

CUBL
Cubo
p. 97

Tonda



CMFS
Campana
p. 111



CMFB
Campana
p. 111



VSLC
Cachepot
p. 110



COMP
Tronco conico
p. 108



CNS PV
Portavaso
p. 108



VALPO
Vaso a parete
p. 109



VALMO
Vaso angolare
p. 109

Leviga



CLSB
Conchino
p. 114



CSL
Conchino
p. 117



CSLT
Ciotola
p. 114

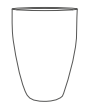

TROCO
Tronco conico
p. 114



VCSD
Orcio
p. 116

Crespia



CSPBO
Cachepot
p. 120



TROBB
Tronco conico
p. 120



PRIBO
Tronco conico
p. 123



COVGL
Cassetta ovale
p. 120



VPCL
Vaso pensile
p. 121

Lombardia

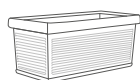

CRI
Cassetta
p. 128

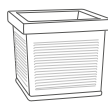

QUM
Cubo
p. 128



PMI
Vaso a parete
p. 128

Country



CMRO
Campana
p. 132



CTLEC
Ciotola
p. 132



CASTOR
Cassetta ovale
p. 133

Impero



CNFA
Campana
p. 136



CALEG
Calice
p. 136



CAFE
Calice
p. 137

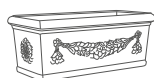

CFE
Cassetta
p. 139



QUCO
Cubo
p. 139



PFRI
Vaso a parete
p. 138



PFSA
Gerla a muro
p. 138

Agrigento



CIPO
Cilindro
p. 145



CIPOH
Cilindro
p. 145



CTPO
Ciotola
p. 145



CAPOR
Cassetta
p. 145



QUPO
Cubo
p. 145

Classico impruneta



CISO
Cilindro
p. 149



CMDB
Campana
p. 149



CTLP
Ciotola
p. 148



CSPCI
Cachepot
p. 148

Nastro



CMFL
Campana
p. 152



COFA
Tronco conico
p. 153

Telcom, l'azienda

Telcom,
the company

La Telcom SPA si distingue per lo sviluppo di prodotti innovativi realizzati in materie termoplastiche, che contribuiscono in vario modo a migliorare la qualità della vita di chi li utilizza, unendo design italiano, solidità e funzionalità.

Telcom Spa is distinguished by the development of innovative products made of thermoplastics, which contribute in various ways to improve the quality of life of users, combining Italian design, strength and functionality.



Creiamo prodotti seguendo i principi di qualità e rispetto dell'ambiente, e lo facciamo da più di cinquant'anni.

We create products by following the principles of quality and respect of the environment, and we do it for more than fifty years.

110.000 m2 di
strutture aziendali
su tre sedi

110.000 m2
premises on three
factories

8 brand di
proprietà Telcom

8 brands own
by Telcom

3 sedi in Italia,
Romania, Albania

3 branches in
Italy, Romania, Albania



Telcom
company profile

Processi produttivi
integrati in azienda

Fully integrated
production processes

Design per un futuro sostenibile

Design for a
sustainable future

Telcom si impegna per la sostenibilità, garantendo che i suoi prodotti abbiano un impatto ambientale minimo. Vogliamo dare nuova vita alla plastica e ridurre l'impatto delle nostre attività sull'ambiente. Per questo pensiamo alla sostenibilità, in tutto ciò che facciamo. Scopri i nostri prodotti.

Telcom is committed to sustainability, ensuring that its products have minimal environmental impact. We want to give new life to plastics and reduce the impact of our activities on the environment. That is why we think about sustainability, in everything we do. Discover our products.

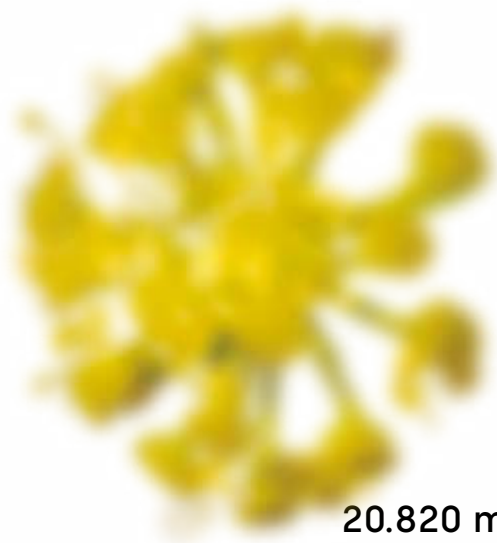

**20.820 m²
di pannelli fotovoltaici
sul territorio nazionale**

20.820 m² of photovoltaic
panels on the national territory

**2088 ton di CO₂
risparmiata in
media all'anno**

2088 tons of CO₂ saved
in average per year

**3.031.000 KW/h di
energia pulita e
rinnovabile all'anno**

3.031.000 KW/h of clean and
renewable energy per year

**Quantità sempre
maggiore di plastica
riciclata nelle collezioni**

Use of an ever-increasing quantity of
recycled plastic in our collections

**Tutti i prodotti sono
realizzati in materiale
100% riciclabile**

All products are made of
100% recyclable material

**Riciclo al nostro
interno di acqua e
scarti di produzione**

Recycling of water and
production waste in-house

MATERIALE

**Il colore Carbon è prodotto con
materia prima 100% riciclata**

MATERIAL

The Carbon color is made from
100% recycled raw material

Più di semplici certificazioni: una missione

More than simple
certifications:
it is a mission

Agenda 2030: gli Obiettivi di Sviluppo Sostenibile già raggiunti

Agenda 2030: the Sustainable
Development Goals we have
already reached

Obiettivo 3:
Salute e benessere

Goal 3: Good health
and well-being

Obiettivo 5:
Uguaglianza di
genere

Goal 5:
Gender equality

Obiettivo 6:
Acqua pulita e igiene

Goal 6: Clean water
and sanitation

Obiettivo 8:
Lavoro dignitoso e
crescita economica

Goal 8:
Decent work and
economic growth

Obiettivo 9:
Imprese, innovazione
e infrastrutture

Goal 9: Industry,
innovation and
infrastructure

Obiettivo 10:
Ridurre le
disuguaglianze

Goal 10:
Reduced
inequalities

Obiettivo 12:
Consumo e
produzione
responsabili

Goal 12:
Responsible
consumption
and production

Obiettivo 13:
Lotta contro il
cambiamento
climatico

Goal 13:
Climate
action

Obiettivo 15:
Vita sulla Terra

Goal 15:
Life on Land



Operatore economico autorizzato

Authorised
economic
operator



Gestione qualità

Quality
management



Gestione ambientale

Environmental
management



Gestione della salute e sicurezza sul lavoro

Management
of health and
safety at work

Le certificazioni rappresentano per noi non solo un riconoscimento, ma anche uno strumento per misurare e migliorare costantemente il nostro impatto. Siamo impegnati a trasformare i nostri principi in azioni concrete, per un equilibrio tra innovazione, rispetto per l'ambiente e benessere delle persone.

Certifications are not only a recognition for us, but also a tool to measure and constantly improve our impact. We are committed to translating our principles into concrete actions, for a balance between innovation, respect for the environment and people well-being.

Un impegno concreto verso l'uguaglianza di genere: la normativa UNI/PdR 125:2022

A concrete commitment towards gender equality: the UNI/PdR 125:2022

La parità di genere non è solo un valore, ma una responsabilità. Telcom S.p.A. è orgogliosa di essere certificata secondo la normativa UNI/PdR 125:2022, che testimonia il nostro impegno nel garantire un ambiente di lavoro inclusivo ed equo.

Gender equality is not only a value, but also a responsibility. Telcom S.p.A. is proud to be certified according to the UNI/PdR 125:2022 standard, which testifies our commitment to ensuring an inclusive and fair working environment.

EQUITÀ E INCLUSIONE

Promuoviamo pari opportunità in tutte le fasi lavorative, dalla progettazione alla produzione.

EQUITY AND INCLUSION

We promote equal opportunities in all the work stages, from design to production.

VALORIZZAZIONE DEL TALENTO

Crediamo che ogni persona debba avere le stesse opportunità di crescere professionalmente, senza discriminazioni.

ENHANCEMENT OF TALENT

We believe that everyone should have the same opportunities to grow professionally, without discrimination.

RESPONSABILITÀ SOCIALE

Questa certificazione è il risultato del nostro impegno verso una cultura aziendale che valorizza il contributo di ogni individuo.

SOCIAL RESPONSIBILITY

This certification is the result of our commitment to a corporate culture that values the contribution of each individual.



Impegno per una produzione responsabile

Commitment to responsible production

PROGETTAZIONE DESIGN



Creatività e innovazione si uniscono nella linea Vasar: tecnologia CAD/CAM e design Made in Italy creano vasi unici, fondendo artigianato e precisione digitale, ispirati alla natura.

Creativity and innovation come together in the Vasar line: CAD/CAM technology and Made in Italy design create unique pots, blending craftsmanship with digital precision, inspired by nature.

STAMPAGGIO MOLDING



Telcom utilizza tecnologie avanzate di stampaggio rotazionale e a iniezione per produrre la sua linea di vasi Vasar, garantendo una produzione di alta qualità e a basso impatto ambientale.

Telcom utilizes advanced rotational and injection molding technologies to produce its Vasar line of planters, ensuring both high-quality and sustainable production.

IMBALLAGGIO PACKAGING

LOGISTICA LOGISTICS



Telcom si impegna per la sostenibilità con confezionamenti eco-green e materiali riciclabili a basso impatto ambientale. Ogni fase riduce l'impronta ecologica, esaltando il valore dei prodotti Vasar.

Telcom is committed to sustainability with eco-green packaging and recyclable, low environmental impact materials. Each phase minimizes the ecological footprint, highlighting the value of Vasar products.

La distribuzione di Telcom si basa su un'efficiente logistica e un magazzino di 40.000 mq automatizzato con il sistema LGV, grazie all'ausilio di sensori e connessioni wireless per il trasporto di prodotti finiti.

Telcom's distribution is based on efficient logistics and a 40,000 sqm automated warehouse supported by LGVs, using sensors and wireless connections to transport finished products.

Telcom e la tecnologia rotazionale

Telcom and rotational technology

Prestiamo particolare attenzione a ogni dettaglio, perché è proprio durante la fase di post-produzione e nella rifinitura manuale che ogni nostro manufatto prende vita. Ogni vaso, perfezionato con cura artigianale, si distingue per la sua unicità e per l'altissima qualità che lo contraddistingue.

We pay close attention to every detail, as it is during the post-production phase and the meticulous finishing process that each of our creations comes to life. Each pot, refined with exceptional care, stands out for its uniqueness and outstanding quality.

01.	2.000 articoli differenti con volume da 10 litri a 50.000 litri	2,000 different articles with volumes from 10 liters to 50,000 liters
02.	4.500 tonnellate di polietilene lavorate ogni anno	4,500 tons of polyethylene processed every year
03.	8 impianti avanzati di stampaggio rotazionale di diverse dimensioni	8 advanced rotational molding plants of various sizes
04.	Impianto produttivo innovativo che permette libertà nel design e nelle texture	Innovative production facility that enables freedom in design and textures



Vasar, in equilibrio tra innovazione e tradizione

Vasar, balancing
innovation and
tradition

Vasar è un modo per portare la bellezza naturale negli spazi quotidiani. Le nostre creazioni uniscono tradizione e innovazione, trovando l'equilibrio tra materiali e forme delicate, focalizzandosi su uno stile che si fonde naturalmente con qualsiasi ambiente.

Vasar is a way to bring natural beauty into everyday spaces. Our creations combine tradition and innovation, striking a balance between materials and delicate forms, focusing on a style that seamlessly blends with any environment.

Un design che parla di stile e rispetto per la natura, rendendo ogni oggetto un'espressione delicata della sua bellezza.

A design that embodies style and respect for nature, making each piece a delicate expression of its beauty.

01. ELEGANZA SENZA TEMPO

Le creazioni di Vasar vanno oltre le mode. Sono fatte per durare, per raccontare una storia di raffinatezza e calma, in perfetta armonia con lo spazio che le accoglie.

01. TIMELESS ELEGANCE

Vasar's creations go beyond fashions. They are made to last, to tell a story of sophistication and calm, in perfect harmony with the space that welcomes them.

02. LA FORZA DELLA SEMPLICITÀ

Con il suo design, Vasar celebra l'essenza della natura in modo universale. Ogni dettaglio evoca emozioni sincere, creando un legame tra spazi, culture e generazioni.

02. THE POWER OF SIMPLICITY

With its design, Vasar celebrates the essence of nature in a universal way. Every detail evokes sincere emotions, creating a link between spaces, cultures and generations.

03. UN'ESTETICA DA VIVERE

Le linee sono morbide e naturali, per creare un'estetica che invita a rilassarsi e apprezzare la semplicità delle forme pure.

03. AN AESTHETICS TO BE EXPERIENCED

The lines are soft and natural, to create an aesthetic that invites you to relax and appreciate the simplicity of pure forms.

**Vogliamo creare connessioni
autentiche tra le persone unite
dalla passione per il garden, dove
Vasar diventa punto d'incontro.**

We aim to create authentic
connections among people
united by their passion for
gardening, where Vasar
becomes a meeting point.

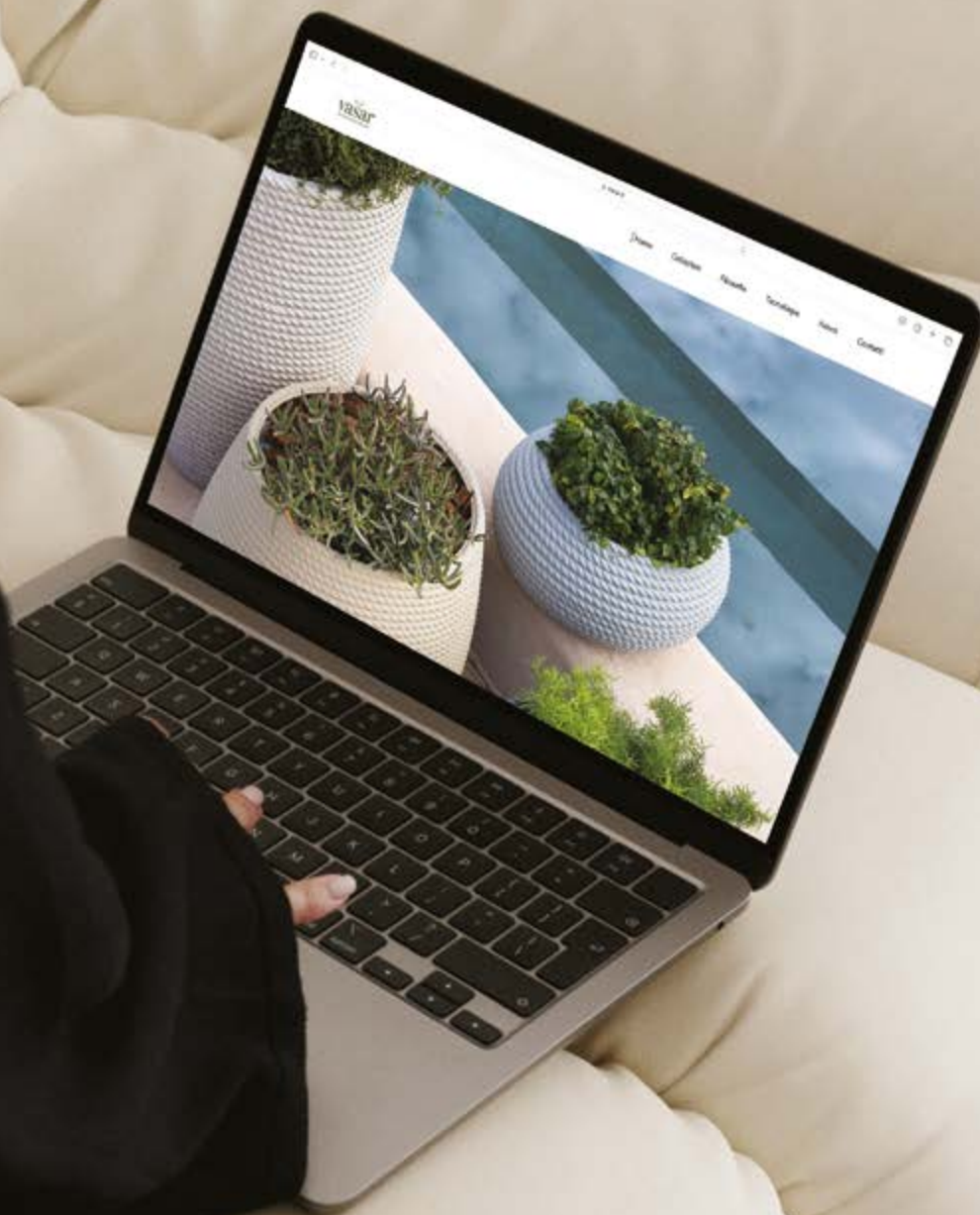

NOVITÀ PRODOTTI

NEW PRODUCTS

All'interno delle nostre piattaforme digitali, potrete restare sempre aggiornati sulle ultime novità dei nostri prodotti, assicurandovi di non perdervi nulla.

Within our digital platforms, you can stay constantly updated on the latest news about our products, ensuring you don't miss anything.

CONSIGLI E IDEE

TIPS AND IDEAS

Amiamo condividere con voi consigli e suggerimenti sul mondo del garden, insieme ai trend e alle ultime novità del settore. E ovviamente amiamo ascoltare la vostra opinione e lasciarci ispirare.

We love sharing tips and advice with you about the world of gardening, along with trends and the latest industry news. And of course, we love hearing your opinions and finding inspiration in them.

EVENTI VASAR

VASAR EVENTS

Nel nostro sito troverete la sezione "Eventi", dove potrete scoprire tutte le date per incontrarci a fiere e giornate dedicate al mondo del garden.

On our website, you'll find the "Events" section, where you can discover all the dates to meet us at trade fairs and days dedicated to the world of gardening.



Vasar website

 vasar_telcom

 Vasar

MOOD ABOUT
COLLECTIONS

Intrecci Tattili

Touch-sensitive twists

La materia si rivela al tatto, trame intrecciate che esaltano la bellezza di ciò la natura crea. Superfici ricche di dettagli evocano una sensorialità autentica. Un equilibrio tra naturalezza e artigianalità, dove la matericità si fa protagonista.

The material reveals itself to the touch, with intertwined textures that enhance the beauty of nature's creations. Surfaces rich in detail evoke an authentic sensory experience. A balance between naturalness and craftsmanship, where the materiality takes center stage.

COLLECTIONS

Shabby

Bambù

Bouclé

Trame



Collezione Shabby

Shabby
collection

77

SHABBY
Portavaso
quadro
PIL PV 75

67

SHABBY
Portavaso
TCRI PV 70

OG

SHABBY
Sfera
SFRI 40

GH

SHABBY
Campana
CMHA 45

67

SHABBY
Cubo
CUBRI 35

BW

SHABBY
Campana
CMHA 45

BW

SHABBY
Tronco
conico
TBRI 30

67

SHABBY
Portavaso
TCRI PV 70

77

SHABBY
Portavaso
quadro
PIL PV 75





BW

SHABBY
Conchino
CORI 45



BW

SHABBY
Ciotola
CTFS 35

67

SHABBY
Sfera
SFRI 40

SHABBY

Raccoglitore
acqua piovana
SHABBYRAIN 150



GH

SHABBY
Vaso pensile
VPBSH 25

77

67

GH

SHABBY
Gerla a muro
GERSY 30





67

SHABBY
Portavaso
COSY PV 85

GH

SHABBY
Cassetta alta
CATLR 78

77

SHABBY
Cassetta alta
CASR PV 93

67

SHABBY
Sfera
SFRI 40

67

SHABBY
Cassetta
CATRI 78

GH

SHABBY
Cassetta
BASV 78





BW

SHABBY
Vaso urbano
ACASHAB 110

Intrecci tattili | Touch-sensitive twists



Shabby

Conchino
CORI



Codice Code				
CORI 27	27	26	12 Lt	NSTVC 20
CORI 35	35	34	25 Lt	NSTVC 28
CORI 45	45	43,5	55 Lt	NSTVC 34
CORI 55	56	60	123 Lt	NSTVC 38
Colori Colors				
Specifiche tecniche Technical specifications				

Shabby

Campana
CMHA



Codice Code				
CMHA 45	45	37	32Lt	NSTVC 28
CMHA 55	55	44,5	61 Lt	NSTVC 34
Colori Colors				
Specifiche tecniche Technical specifications				

Shabby

Ciotola
CTFS

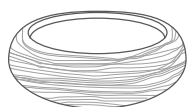

Codice Code			
CTFS 35		35	11
CTFS 42		42	12,5
CTFS 50		50	15
Colori Colors			
Specifiche tecniche Technical specifications			

Shabby

Sfera
SFRI

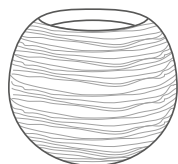

Codice Code			
SFRI 30		30	24
SFRI 40		40	33
SFRI 50		50	42
Colori Colors			
Specifiche tecniche Technical specifications			

Shabby

Tronco conico
TBRI

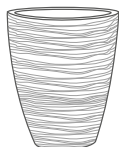

Codice
Code



TBRI 30

30

36

20 Lt

NSTVC 20

TBRI 37

37

44

35 Lt

NSTVC 24

Colori
Colors

77

67

GH

BW

OG

Specifiche tecniche
Technical specifications



Shabby

Portavaso
TCRI PV

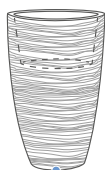

Codice
Code



TCRI PV 70

40

70

18 Lt

23

33

Colori
Colors

77

67

GH

BW

OG

Specifiche tecniche
Technical specifications



Shabby

Portavaso
COSY PV



Codice
Code



COSY PV 85

38,5

85

28 Lt

26

26

Colori
Colors

77

67

GH

BW

OG

Specifiche tecniche
Technical specifications



Shabby

Portavaso quadro
PIL PV



Codice
Code



PIL PV 75

32x32

75

18 Lt

24

28

Colori
Colors

77

67

GH

BW

OG

Specifiche tecniche
Technical specifications



Shabby

Cassetta
BASY

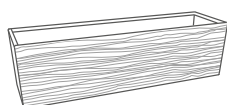

Codice
Code



BASY 78

78x22

22

32 Lt

Colori
Colors

77

67

GH

BW

OG

Specifiche tecniche
Technical specifications



Shabby

Cassetta
CATRI

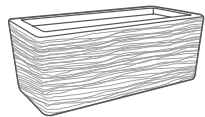

Codice
Code

CATRI 78



79x35



30



66 Lt

Colori
Colors

77

67

GH

BW

OG

Specifiche tecniche
Technical specifications



Shabby

Cassetta alta
CATLR

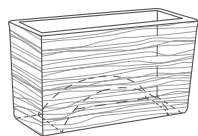

Codice
Code

CATLR 78



78x35



61



115 Lt

Colori
Colors

77

67

GH

BW

OG

Specifiche tecniche
Technical specifications



Shabby

Cassetta alta
CASR PV

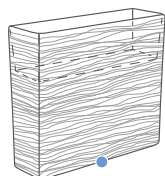

Codice
Code

CASR PV 93



84x24



77



51 Lt



23



84x24

Colori
Colors

77

67

GH

BW

OG

Specifiche tecniche
Technical specifications



Shabby

Cubo
CUBRI

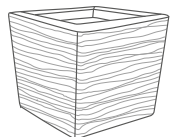

Codice
Code

CUBRI 35



35x35



30



30 Lt

Colori
Colors

77

67

GH

BW

OG

Specifiche tecniche
Technical specifications



Shabby

Vaso urbano
ACASHAB



Codice
Code

ACASHAB 110



106



71



510 Lt

Colori
Colors

77

67

GH

BW

OG

Specifiche tecniche
Technical specifications



Shabby

Gerla a muro
GERSY



Codice
Code



GERSY 30*

30X18

24

7 Lt

Colori
Colors

77

67

GH

BW

OG

Specifiche tecniche
Technical specifications

*Con riserva d'acqua / With water reserve



Shabby

Vaso pensile
VPBSH



Codice
Code



VPBSH 25

25

19

5,6

Colori
Colors

77

67

GH

BW

OG

Specifiche tecniche
Technical specifications



Shabby

Raccoglitore acqua piovana
RAIN



Codice
Code



RAIN 150

46

106

155

7

28

RAIN 300

66

113

297

7

43

Colori
Colors

67

GH

I

Specifiche tecniche
Technical specifications



Collezione Bambù

Bambù
collection



FA

BAMBÙ
Cassetta alta
CANTL 78

OG

BAMBÙ
Conchino
CONCAN 40

FA 77

BAMBÙ
Conchino
CONCAN 40

FA

BAMBÙ
Cassetta alta
CANTL 78



Bambù

Conchino
CONCAN

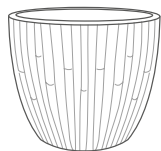

Codice
Code

CONCAN 40



42



35



24 Lt

Colori
Colors

77

FA

OG

Specifiche tecniche
Technical specifications



Bambù

Cassetta alta
CANTL

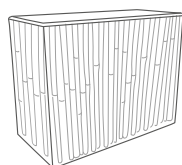

Codice
Code

CANTL 78



81x37



63



168 Lt

Colori
Colors

77

FA

OG

Specifiche tecniche
Technical specifications





Collezione Bouclé

Bouclé
collection

46

BOUCLÉ
Cilindro
CILBOU 45



46

BOUCLÉ
Cilindro
CILBOU 45





BOUCLÉ
Cilindro
CILBOU 35



BOUCLÉ
Cilindro
CILBOU 40



BOUCLÉ
Cilindro
CILBOU 45



Bouclé

Cilindro
CILBOU

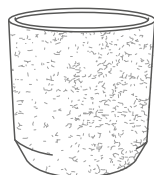

Codice
Code

CILBOU 35

CILBOU 40

CILBOU 45

Colori
Colors

Specifiche tecniche
Technical specifications



35

37

26,5 Lt

40

46

43,5 Lt

46

46

57 Lt

77

I

46

DE

VV

56



Bouclé

Cassetta
CASBOU

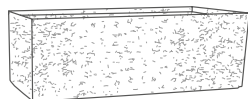

Codice
Code

CASBOU 80

CASBOU 100 - COMING SOON

Colori
Colors

Specifiche tecniche
Technical specifications



83x40

40

95 Lt

100x34

40

129 Lt

77

I

46

DE

VV

56



Bouclé

Cassetta alta
CASHBOU

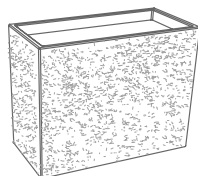

Codice
Code

CASHBOU 78 - COMING SOON

Colori
Colors

Specifiche tecniche
Technical specifications



/

/

/

77

I

46

DE

VV

56



Bouclé

Vaso urbano
ACABOU

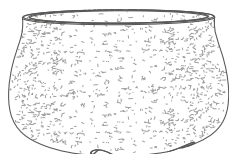

Codice
Code

ACABOU 60- COMING SOON

Colori
Colors

Specifiche tecniche
Technical specifications



60

40

95 Lt

77

I

46

DE

VV

56





Collezione Trame

Trame
collection

67

TRAME
Cilindro
TICIL 35

DW

SACCO
Cilindro
SACCO 45

DW

SACCO
Cilindro
SACCO 45

67

SACCO
Cilindro
SACCO 45





TRAME
Cilindro
TICIL 35



Sacco

Cilindro
SACCO

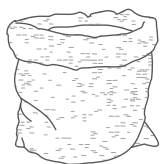

Codice
Code



SACCO 27

27

22

8,3 Lt

SACCO 45

47

37

44 Lt

SACCO 70

70

50

107 Lt

Colori
Colors



Specifiche tecniche
Technical specifications



Trame

Cilindro
TICIL

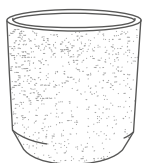

Codice
Code



TICIL 35

36

40

29,5 Lt

Colori
Colors



Specifiche tecniche
Technical specifications





MOOD ABOUT
COLLECTIONS

Sussurri Marini

Sea waves whispers

Una brezza marina attraversa gli spazi, accarezzando superfici e portando con sé la calma dell'estate. Riflessi vibranti di un'estate lontana si intrecciano in forme morbide e tinte vivaci, evocando la freschezza della costa e il suo equilibrio naturale.

A sea breeze flows through the spaces, gently brushing over surfaces and bringing with it the calm of summer days. Vibrant reflections of a distant summer intertwine with soft shapes and vivid hues, evoking the freshness of the coast and its natural harmony.

COLLECTIONS

Bali



Collezione Bali

Bali
collection



67

BALI
Portavaso
BOMCORD PV 70

91

BALI
Ciotola
CIOCORD 40

46

BALI
Conchino
CONCORD 35

1

BALI
Conchino
CONCORD 20



BALI
Vaso urbano
ACACORD 78



91

BALI
Conchino
CONCORD 35

95

BALI
Ciotola
CIOCORD 40



67

BALI
Portavaso
BOMCORD PV 70

GD

BALI
Sfera
SFERCORD 40

77

BALI
Cilindro
CILCORD 60

67

BALI
Cassetta
CASCORD 80

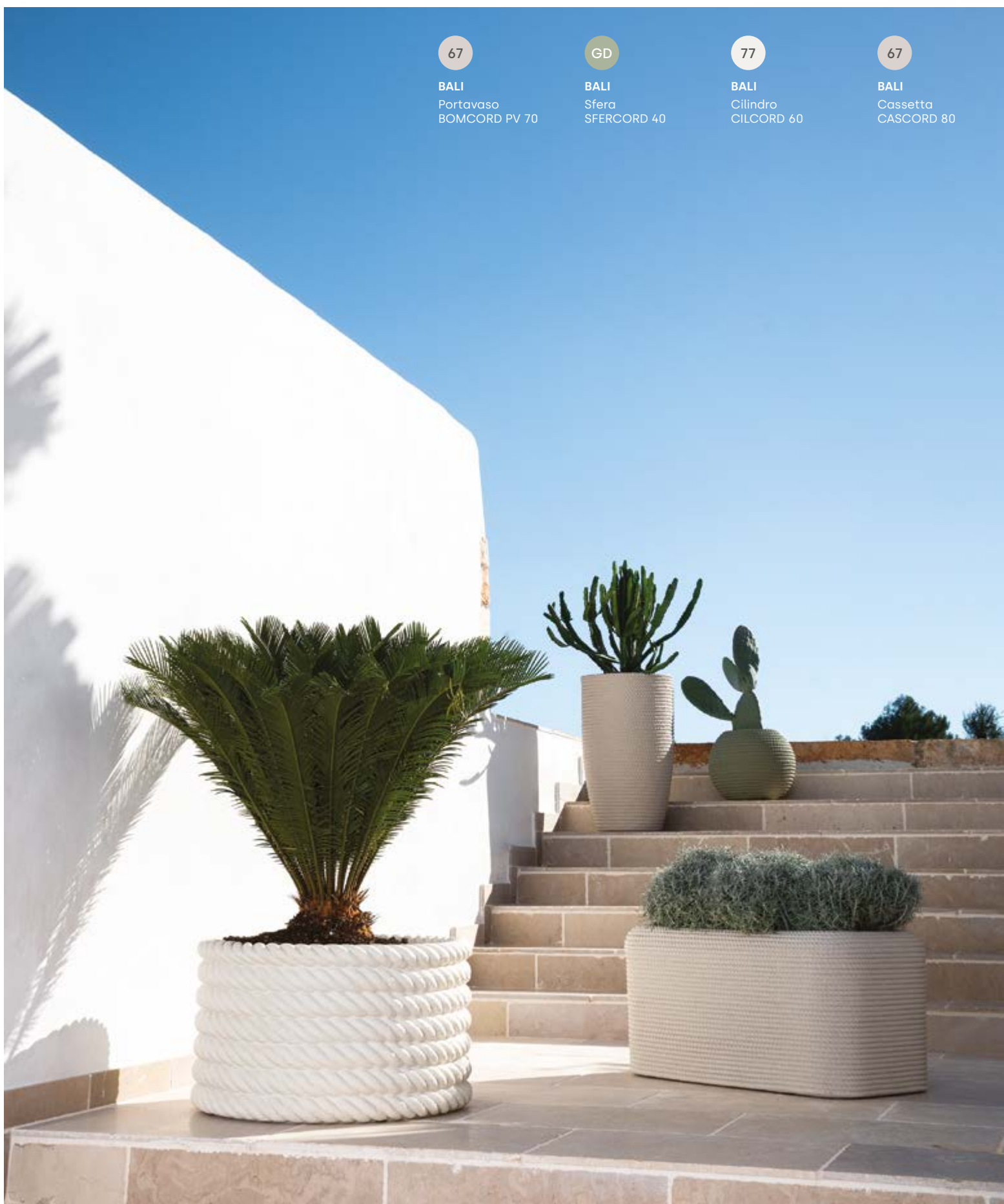

Bali
Conchino
CONCORD

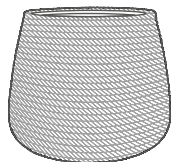

Codice
Code



CONCORD 20

40

32

23 Lt

CONCORD 35

49

41

56 Lt

Colori
Colors



Specifiche tecniche
Technical specifications



Giava
Cilindro
CILCORD

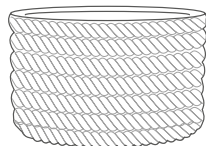

Codice
Code



CILCORD 60

68

40

124 Lt

CILCORD 80

80

61

265 Lt

Colori
Colors

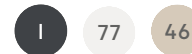

Specifiche tecniche
Technical specifications



Bali
Ciotola
CIOCORD

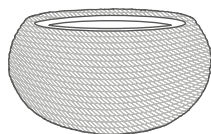

Codice
Code



CIOCORD 40

40

21

14 Lt

CIOCORD 50

51

25

29 Lt

Colori
Colors



Specifiche tecniche
Technical specifications



Bali
Sfera
SFERCORD

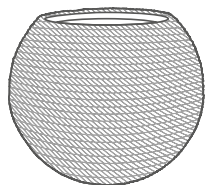

Codice
Code



SFERCORD 40

40

34

23 Lt

SFERCORD 50

55

43

60 Lt

Colori
Colors



Specifiche tecniche
Technical specifications



Bali

Portavaso
BOMCORD PV

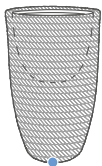

Codice
Code



BOMCORD PV 70

41

70

18 Lt

23

33

Colori
Colors



Specifiche tecniche
Technical specifications



Bali

Cassetta
CASCORD

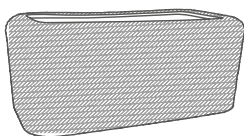

Codice
Code



CASCORD 80

85x45

45

130 Lt

Colori
Colors



Specifiche tecniche
Technical specifications



Bali

Vaso urbano
ACACORD

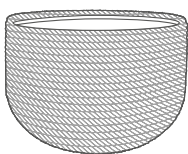

Codice
Code



ACACORD 78

80

50

172 Lt

Colori
Colors



Specifiche tecniche
Technical specifications



MOOD ABOUT
COLLECTIONS

Tenui Atmosfere

Warm atmospheres

Ombre soffuse che avvolgono lo spazio, forme sinuose che trasmettono equilibrio e calma. La morbidezza delle linee e i toni neutri creano atmosfere accoglienti, in cui ogni dettaglio evoca serenità. Una delicatezza che rende lo spazio leggero e armonioso.

Soft shadows envelop the space, with flowing shapes that convey balance and calm. The softness of the lines and neutral tones create inviting atmospheres, where every detail evokes serenity. A delicacy that makes the space light and harmonious.

COLLECTIONS

Gaudi

Bubble

Acaya



Collezione Gaudi

Gaudi
collection



97

GAUDI
Cachepot
VSGU 55

BI

GAUDI
Cachepot
VSGU 45

71

GAUDI
Conchino
CTGU 35

97

GAUDI
Cassetta ovale
CSGU 87

71

GAUDI
Conchino
CTGU 35

BI

GAUDI
Cachepot
VSGU 45

97

GAUDI
Cachepot
VSGU 55



Gaudì

Conchino
CTGU

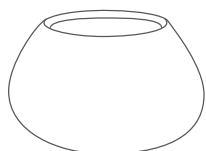

Codice
Code



CTGU 35

64X61

37

75 Lt

Colori
Colors



Specifiche tecniche
Technical specifications



Gaudì

Cachepot
VSGU 45



Codice
Code



VSGU 45

67X62

45

103

Colori
Colors



Specifiche tecniche
Technical specifications



Gaudì

Cachepot
VSGU 55



Codice
Code



VSGU 55

64x59

55

106

Colori
Colors



Specifiche tecniche
Technical specifications



Gaudì

Cassetta ovale
CSGU



Codice
Code



CSGU 87

85X55

37

102

Colori
Colors



Specifiche tecniche
Technical specifications





Collezione Bubble

Bubble
collection

S3

BUBBLE
Conchino
BCA 35

78

BUBBLE
Portavaso
BFU PV 75

BI

BUBBLE
Conchino
BCI 50



NE

BUBBLE
Portavaso
BFU PV 75



Bubble

Conchino
BCA



Codice
Code



BCA 35

49

40,5

56

Colori
Colors



Specifiche tecniche
Technical specifications



Bubble

Conchino
BCI

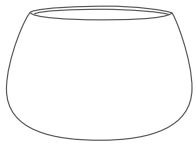

Codice
Code



BCI 50

67

38,5

111

Colori
Colors



Specifiche tecniche
Technical specifications



Bubble

Portavaso
BFU PV

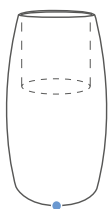

Codice
Code



BFU PV 75

45,5

75

18

20

30

Colori
Colors



Specifiche tecniche
Technical specifications





Collezione Acaya

Acaya
collection



B3

ACAYA
Vaso urbano
ACAYA 84

77

78

BW

ACAYA
Vaso urbano
ACAYA 84



Acaya

Vaso urbano
ACAYA

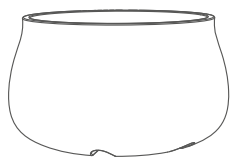

Codice
Code

ACAYA 60

ACAYA 78

ACAYA 84

ACAYA 110

ACAYA 130

Colori
Colors

Specifiche tecniche
Technical specifications



60



40



95 Lt

78

50

172 Lt

84

56

280 Lt

110

70

510 Lt

130

90

1103 Lt

77

78

I

BW

B3





MOOD ABOUT
COLLECTIONS

Frammenti Urbani

Urban fragments

Spazi essenziali, sospesi tra materia e luce, impreziositi da dettagli e forme in grado di creare nuove frammentazioni dell'ambiente. Il pieno respira attraverso il vuoto, amplificando la presenza degli elementi. Geometrie pure emergono con forza, definendo un equilibrio tra solidità e leggerezza.

Essential spaces, suspended between matter and light, enriched by details and forms that create new fragmentations of the environment. The solid breathes through the void, amplifying the presence of the elements. Pure geometries emerge with strength, defining a balance between solidity and lightness.

COLLECTIONS

Ardesia

City

Linea



Collezione Ardesia

Ardesia
collection

67

ARDESIA
Cilindro
CILAR 45

67

ARDESIA
Cassetta
CATLA 80

67

ARDESIA
Cassetta alta
CATLH 75

QZ

ARDESIA
Cubo
CUBLA 30

PH

ARDESIA
Portavaso quadro
CUBLA PV 75

55

ARDESIA
Cubo
CUBLA B 15

B3

ARDESIA
Cassetta alta
CATLH 75





55

ARDESIA
Portavaso
CILAR PV 75

B3

ARDESIA
Cilindro
CILAR 35

PH

ARDESIA
Portavaso quadro
CUBLA PV 75

B3

ARDESIA
Cassetta alta
CATLH 75



Ardesia

Cilindro
CILAR



Codice
Code



CILAR 25

26

30

10 Lt

NSTVC 20

CILAR 35

36

41

28 Lt

NSTVC 32

CILAR 45

46

46

55 Lt

NSTVC 40

Colori
Colors

67

55

PH

QZ

B3

Specifiche tecniche
Technical specifications



Ardesia

Portavaso
CILAR PV



Codice
Code



CILAR PV 75

33

75

14 Lt

22

28,5

Colori
Colors

67

55

PH

QZ

B3

Specifiche tecniche
Technical specifications



Ardesia

Portavaso quadro
CUBLA PV

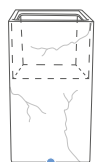

Codice
Code



CUBLA PV 75

30x30

75

12 Lt

21

26

Colori
Colors

67

55

PH

QZ

B3

Specifiche tecniche
Technical specifications



Ardesia

Cassetta
CATLA

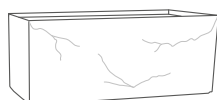

Codice
Code



CATLA 80

81x41

40

112 Lt

CATLA 100

102X41

40

135 Lt

Colori
Colors

67

55

PH

QZ

B3

Specifiche tecniche
Technical specifications



Ardesia

Cassetta alta
CATLH

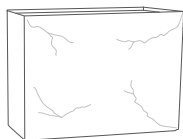

Codice
Code



CATLH 75

80x30

75

171 Lt

Colori
Colors

67

55

PH

QZ

B3

Specifiche tecniche
Technical specifications



Ardesia

Cubo
CUBLA



Codice
Code



CUBLA 30

30x30

40

31 Lt

CUBLA 40

40x40

40

52 Lt

Colori
Colors

67

55

PH

QZ

B3

Specifiche tecniche
Technical specifications



Ardesia

Cubo
CUBLA B

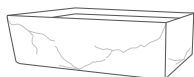

Codice
Code



CUBLA B 15

40,5x40,5

15

17 Lt

Colori
Colors

67

55

PH

QZ

B3

Specifiche tecniche
Technical specifications



Collezione City

City
collection

55

CITY
Portavaso quadro
CURG PV 75

46

CITY
Cilindro
CLRG 45

46

CITY
Portavaso
CLRG PV 70

46

CITY
Cilindro
CLRG 45





55

CITY
Cubo
CURG 40

55

CITY
Cassetta
CSRG 90









55











CITY
Cassetta alta
CSRGH 75









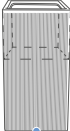

55









CITY
Portavaso quadro
CURG PV 75

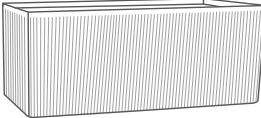

City Cilindro CLRG 	Codice Code			
	CLRG 27	27,5	30	15 Lt
	CLRG 35	36	35	31 Lt
	CLRG 45	46	45	66 LT
	Colori Colors	  		
Specifiche tecniche Technical specifications				

City Portavaso CLRG PV 	Codice Code					
	CLRG PV 70	33	69	14 Lt	22	29
	Colori Colors	  				
	Specifiche tecniche Technical specifications					

City Portavaso quadro CURG PV 	Codice Code					
	CURG PV 75	33x33	75	18 Lt	22	29
	Colori Colors	  				
	Specifiche tecniche Technical specifications					

City Cassetta CSRG 	Codice Code			
	CSRG 90	92x41	33,5	105 Lt
	Colori Colors	  		
	Specifiche tecniche Technical specifications			

City

Cassetta alta
CSRGH

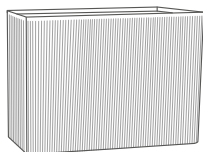

Codice
Code



CSRGH 75

80x33

75

181 Lt

Colori
Colors

55

77

46

Specifiche tecniche
Technical specifications



City

Cubo
CURG

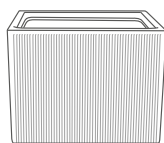

Codice
Code



CURG 30

30x30

40

36 Lt

CURG 40

41x41

33,5

50 Lt

Colori
Colors

55

77

46

Specifiche tecniche
Technical specifications



Collezione Linea

Linea
collection



LINEA
Cassetta alta
CASLINEA PV 90



LINEA
Cassetta
CASLINEA 80



LINEA
Cassetta
CASLINEA 80



LINEA
Cassetta alta
CASLINEA PV 90



Linea

Cassetta
CASLINEA

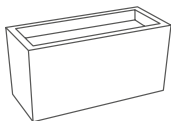

Codice
Code



CASLINEA 80

80x34

39

84 Lt

CASLINEA 100

100x34

39

112 Lt

Colori
Colors



Specifiche tecniche
Technical specifications



Linea

Cassetta alta
CASLINEA PV

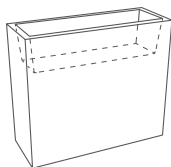

Codice
Code



CASLINEA PV - COMING SOON

/

/

/

Colori
Colors



Specifiche tecniche
Technical specifications



MOOD ABOUT
COLLECTIONS

Pura Essenza

Purest essence



L'essenziale si manifesta in gesti semplici, in forme che appartengono al quotidiano. Spazi familiari che celebrano la semplicità, dove l'umiltà dei dettagli rivela un'eleganza discreta. Un equilibrio naturale che parla di autenticità e bellezza sincera.

The essential is revealed in simple gestures, in shapes that belong to everyday life. Familiar spaces that celebrate simplicity, where the humility of details unveils a discreet elegance. A natural balance that speaks of authenticity and genuine beauty.

COLLECTIONS

Quadra

Tonda

Leviga

Crespia



Collezione Quadra

Quadra
collection



55

MATELICA
Cassetta alta
CATL 78

I

MATELICA
Cassetta
CATL B 78

B3

VIAREGGIO
Cubo
CUBL 40

55

MONTIERI
Portavaso
quadro
LTR PV 85



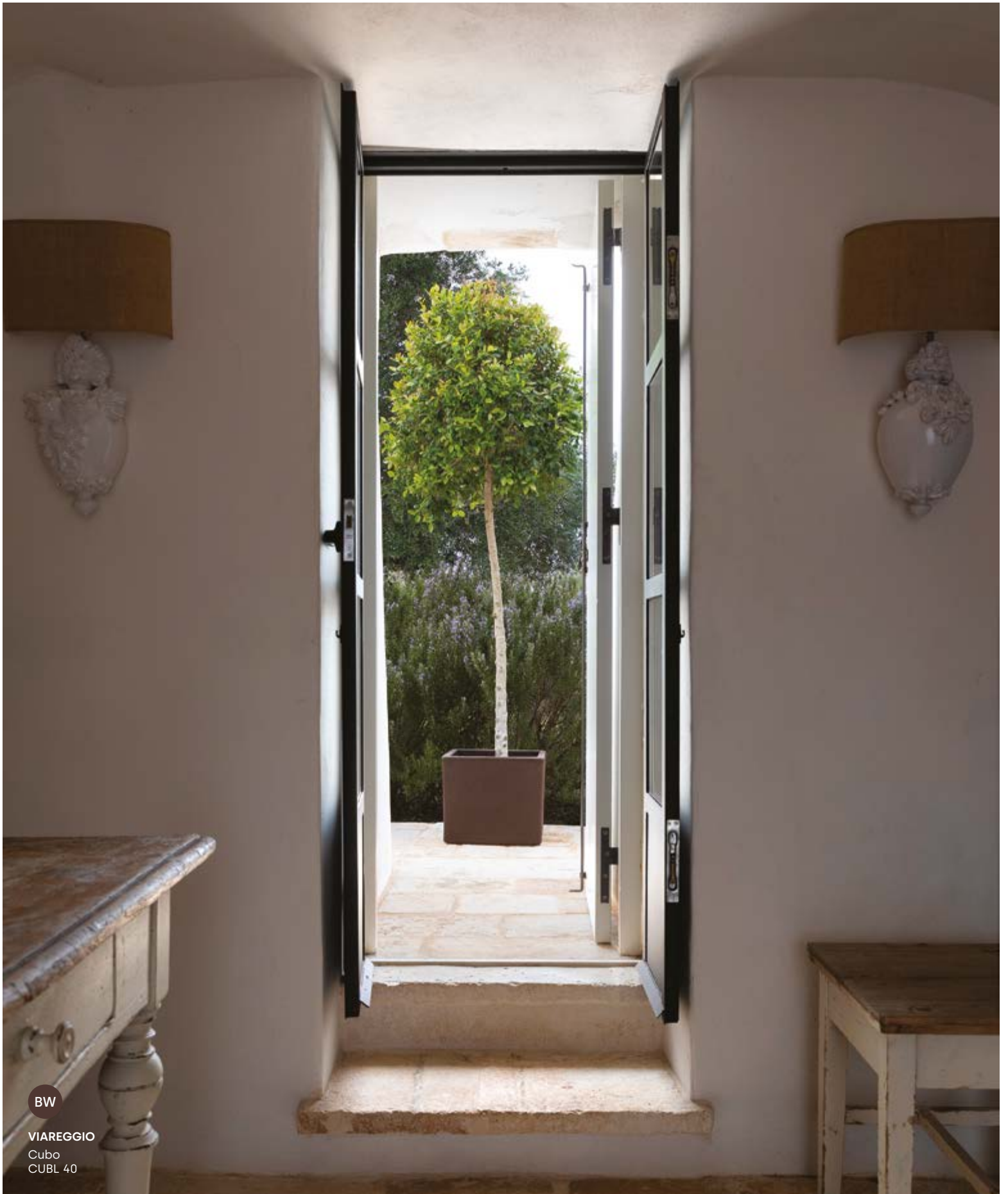

BW

VIAREGGIO

Cubo
CUBL 40

1

SENIGALIA
Cassetta
BATL 50

78

MATELICA
Cassetta
CATL XL 100





LAGO LESINA
Tronco conico
PRICO 40



78

CECINA
Portavaso quadro
QNS PV 85





78

IVREA
Cassetta alta
VNS PV 61

78

VOGHERA
Cassetta alta
CSTS PV 93

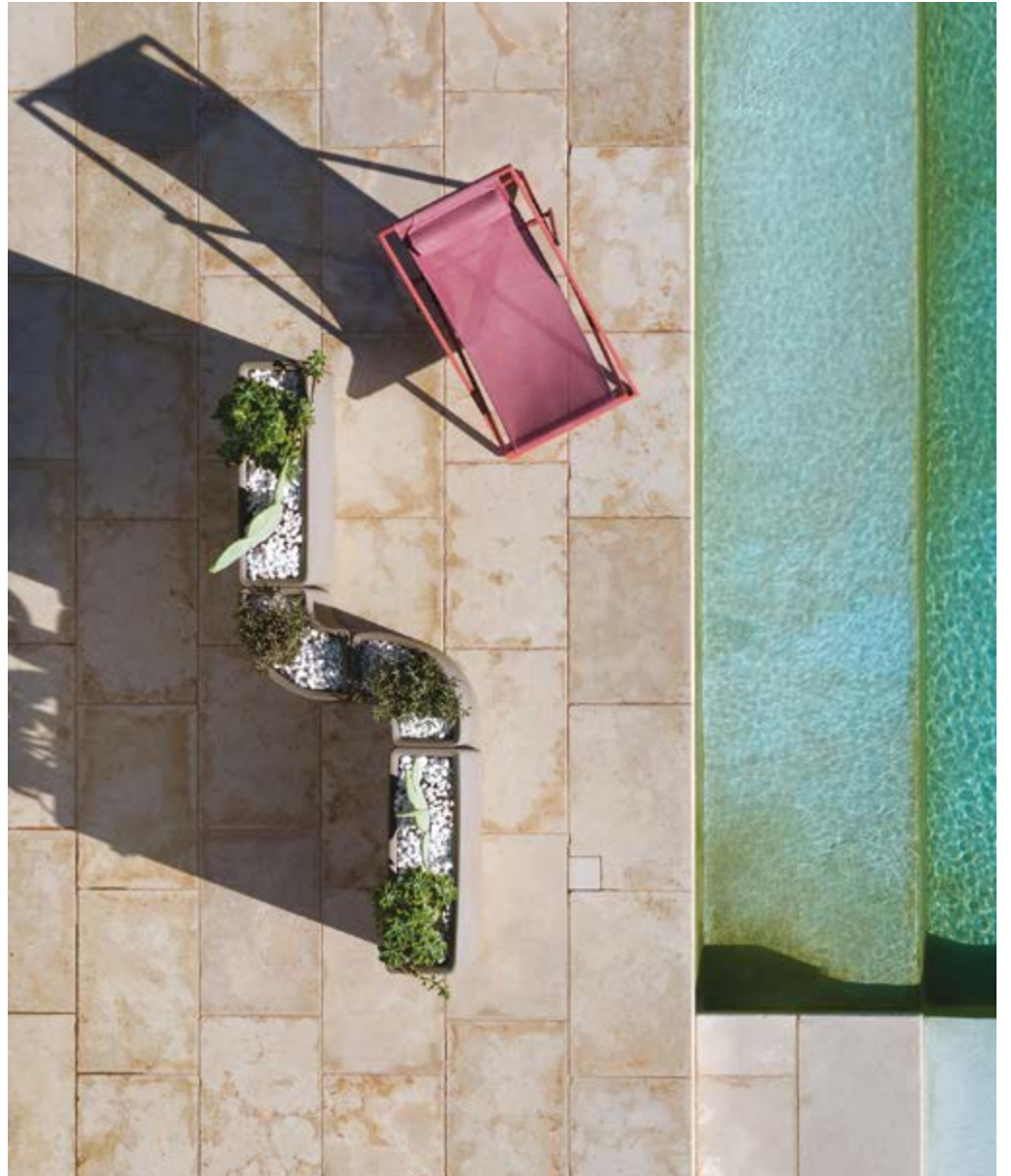

Lago lesina

Tronco conico
PRICO

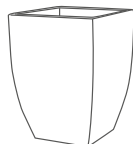

Codice Code					
PRICO 40	30x30	40	28 Lt	/	SVQR 21
PRICO 50	38x38	50	55 Lt	STVQ 30	/
PRICO 60	46x46	60	97 Lt	STVQ 37	/
Colori Colors					77 78 I
Specifiche tecniche Technical specifications					

Montieri

Portavaso quadro
LTR PV

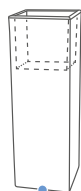

Codice Code					
LTR PV 85	28x28	85	17 Lt	23	25
Colori Colors					55 77 78 I NE
Specifiche tecniche Technical specifications					

Cecina

Portavaso quadro
QNS PV

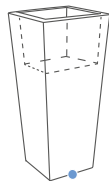

Codice Code					
QNS PV 85	38x38	85	30 Lt	26	32
QNS PV 95	42x42	95	35 Lt	26	36
Colori Colors					77 78 I
Specifiche tecniche Technical specifications					

Matelica

Cassetta
CATL XL 100

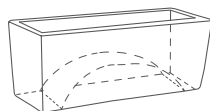

Codice Code					
CATL XL 100	100x40	40	150 Lt	STVR 95	
Colori Colors					77 78 I 55 B3 BW
Specifiche tecniche Technical specifications					

Matelica

Cassetta
CATL B



Codice Code				
CATL B 78	78x35	31	68 Lt	STVR 78
CATL B 100	100x35	31	88 LT	SVR 9934
Colori Colors				
Specifiche tecniche Technical specifications				

Senigallia

Cassetta
BATL



Codice Code				
BATL 50	50x22	22	21 Lt	
BATL 78	78x22	22	32 Lt	
Colori Colors				
Specifiche tecniche Technical specifications				

Matelica

Cassetta alta
CATL

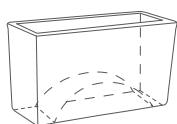

Codice Code				
CATL 75	75x30	42	73 Lt	/
CATL 78	78x35	61	115 Lt	STVR 78
CATL 100	100x35	61	160 Lt	SVR 9533
Colori Colors				
Specifiche tecniche Technical specifications				

Voghera

Cassetta alta
CSTS PV

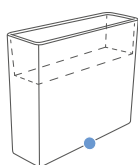

Codice Code					
CSTS PV 93	90x29	77	33 Lt	19	83x22
Colori Colors					
Specifiche tecniche Technical specifications					

Ivrea

Cassetta alta
VNS PV

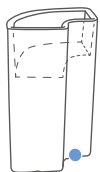

Codice
Code



VNS PV 61

61x28

77

25 Lt

19

53x21

Colori
Colors



Specifiche tecniche
Technical specifications



Viareggio

Cubo
CUBL

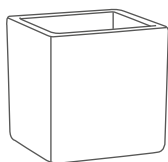

Codice
Code



CUBL 30

30x30

30

18 Lt

CUBL 35

35x35

33

27 Lt

CUBL 40

40x40

35

42 Lt

CUBL 50

50x50

48

84 Lt

CUBL 60

60x60

56

180 Lt

Colori
Colors



Specifiche tecniche
Technical specifications





Collezione Tonda

Tonda
collection

1

TORTONA
Portavaso
CNS PV 95

78

GRAGNANO
Tronco conico
COMP 50

78

GRAGNANO
Tronco conico
COMP 70



77

TARVISIO
Vaso angolare
VALMO 55

77

TOLMEZZO
Vaso a parete
VALPO 60





77

VULCANO
Cachepot
VSLC 50

110

78

GIOVINAZZO

Campana
CMFB 55

78

POLIGNANO

Campana
CMFS 75



Polignano

Campana
CMFS

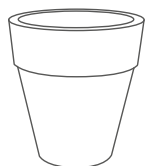

Codice
Code



CMFS 65

65

70

121 Lt

NSTVC 36

CMFS 75

70

75

140 Lt

NSTVC 40

CMFS 85

84

90

256 Lt

NSTVC 46

Colori

Colors

77

78

I

Specifiche tecniche

Technical specifications



Giovinazzo

Campana
CMFB

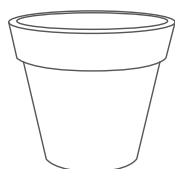

Codice
Code



CMFB 35

35

32

15 Lt

NSTVC 20

CMFB 45

45

40

30 Lt

NSTVC 26

CMFB 55

55

49

58 Lt

NSTVC 32

Colori

Colors

77

78

I

Specifiche tecniche

Technical specifications



Vulcano

Cachepot
VSLC



Codice
Code



VSLC 30

60

35

53 Lt

VSLC 50

60

50

84 Lt

VSLC 70

60

70

120 Lt

Colori

Colors

77

78

I

Specifiche tecniche

Technical specifications



Gragnano

Tronco conico
COMP

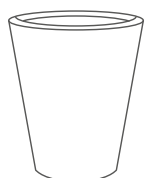

Codice
Code



COMP 50

50

60

39 Lt

NSTVC 36

COMP 60

60

73

67 Lt

NSTVC 42

COMP 70

70

84

95 Lt

NSTVC 48

Colori

Colors

77

78

BW

Specifiche tecniche

Technical specifications



Tortona

Portavaso
CNS PV



Codice Code								
CNS PV 70	31	71	14 Lt	23	28			
CNS PV 85	38,5	85	28 Lt	26	35			
CNS PV 95	42	95	25 Lt	26	38			
Colori Colors								
Specifiche tecniche Technical specifications								

Tolmezzo

Vaso a parete
VALPO



Codice Code				
VALPO 60	57x33	61	80 Lt	
Colori Colors				
Specifiche tecniche Technical specifications				

Tarvisio

Vaso angolare
VALMO



Codice Code				
VALMO 55	74x45	61	100 Lt	
Colori Colors				
Specifiche tecniche Technical specifications				

Collezione Leviga

Leviga
collection



78
SAVONA
Conchino
CLSB 40



78
CAMAIORE
Ciotola
CSLT 45



78
CAMAIORE
Ciotola
CSLT 35



78
PORTO BADISCO
Tronco conico
TROCO 60







55

GUBBIO
Conchino
CSL 35



Savona

Conchino
CLSB



Codice
Code



CLSB 30

30

25

10 Lt

NSTVC 20

CLSB 40

40

33

23 Lt

NSTVC 28

CLSB 50

50

42

50 Lt

NSTVC 36

CLSB 60

60

50

95 Lt

NSTVC 42

Colori
Colors

77

78

1

Specifiche tecniche
Technical specifications



Gubbio

Conchino
CSL

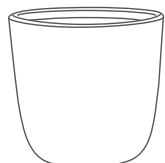

Codice
Code



CSL 30

30

29

15 Lt

NSTVC 24

CSL 35

35

34

24 Lt

NSTVC 26

CSL 45

45

41

50 Lt

NSTVC 34

Colori
Colors

55

77

78

1

Specifiche tecniche
Technical specifications



Camaiore

Ciotola
CSLT



Codice
Code



CSLT 35

37

17

11 Lt

NSTVC 26

CSLT 45

47

22

21 Lt

NSTVC 30

CSLT 55

58

28

42 Lt

NSTVC 36

Colori
Colors

55

77

78

1

Specifiche tecniche
Technical specifications



Porto badisco

Tronco conico
TROCO

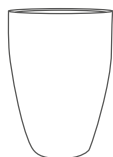

Codice
Code



TROCO 40

30

40

22 Lt

NSTVC 20

TROCO 50

38

50

43 Lt

NSTVC 26

TROCO 60

46

60

78 Lt

NSTVC 30

Colori
Colors

77

78

1

Specifiche tecniche
Technical specifications



Monastir

Orcio
VCSD



Codice
Code



VCSD 44

44

50

46 Lt

Colori
Colors

77

78

Specifiche tecniche
Technical specifications



Collezione Crespia

Crespia
collection

78

CASTRO
Tronco conico
TROBB 36

77

MURGE
Cassetta ovale
COVGL 40

78

CASCINA
Cachepot
CSPBO 36







77

LAGHI ALMINI
Tronco conico
PRIBO 45

77

LAGHI ALMINI
Tronco conico
PRIBO 55



Cascina

Cachepot
CSPBO

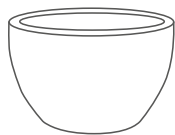

Codice
Code



CSPBO 36

36

23

8 Lt

NSTVC 24

CSPBO 50

50

23

16 Lt

NSTVC 38

Colori
Colors

77

78

99

Specifiche tecniche
Technical specifications



Castro

Tronco conico
TROBB

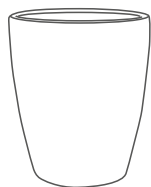

Codice
Code



TROBB 28

24

28

6 Lt

NSTVC 16

TROBB 36

30

36

15 Lt

NSTVC 20

TROBB 44

37

44

27 Lt

NSTVC 24

Colori
Colors

77

78

I

Specifiche tecniche
Technical specifications



Laghi alimini

Tronco conico
PRIBO

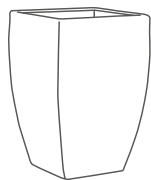

Codice
Code



PRIBO 35

23x23

35

12 Lt

SVQR 16

PRIBO 45

30x30

45

27 Lt

SVQR 21

PRIBO 55

36x36

55

50 Lt

SVQR 25

Colori
Colors

77

I

Specifiche tecniche
Technical specifications



Murge

Cassetta ovale
COVGL



Codice
Code



COVGL 40

40x25

17

9 Lt

COVGL 46

46x28

19

12 Lt

Colori
Colors

77

I

Specifiche tecniche
Technical specifications



Stelvio

Vaso pensile
VPCL



Codice
Code

VPCL 25

Colori
Colors

Specifiche tecniche
Technical specifications



25



35



3 Lt

77

78

99

Con catenella
With chain

MOOD ABOUT
COLLECTIONS

Radici Mediterranee

Mediterranean Roots

Profumi di terra e mare, tradizioni che affiorano tra antichi colori e linee senza tempo. Spazi che raccontano il calore mediterraneo, fatti di tonalità e dettagli che richiamano una cultura autentica. Un ritorno alle origini, dove ogni elemento celebra l'eterna bellezza del passato.

Scents of earth and sea, traditions emerging through ancient colors and timeless lines. Spaces that embody Mediterranean warmth, crafted with tones and details that reflect an authentic culture. A return to origins, where every element celebrates the eternal beauty of the past.

COLLECTIONS

Lombardia

Country

Impero



Collezione Lombardia

Lombardia
collection



99

LOMBARDIA
Vaso a parete
PMI 40/4

99

LOMBARDIA
Cubo
QUM 35

99

LOMBARDIA
Cassetta
CRI 80

99

LOMBARDIA
Cubo
QUM 35

99

LOMBARDIA
Vaso a parete
PMI 40/4

99

LOMBARDIA
Cassetta
CRI 80



Lombardia

Cassetta
CRI

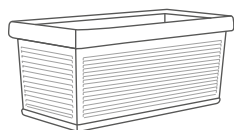

Codice Code					
CRI 50	50x26	24	17 Lt	/	SVRR 45/L
CRI 60	63x33	29	33 Lt	STVR 59	/
CRI 70	73x35	31	44 Lt	SVR 6931	SVRR 67/B
CRI 80/3	83x38	34	43 Lt	STVR 78	SVRR 77
CRI 100/3	100x38	34	53 Lt	SVR 9533	/
CRI 90	93x42	37	91 Lt	STVR 88	SVRR 87
CRI 101/4	103x47	40	89 Lt	STVR 108	SVRR 95/4
CRI 120/4	120x47	40	100 Lt	/	SVRR 113

Colori
Colors

99

Specifiche tecniche
Technical specifications



Lombardia

Cubo
QUM

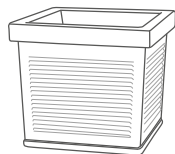

Codice Code					
QUM 30	32x32	27	14 Lt	STVQ 30	/
QUM 35/3	37x37	34	27 Lt	STVQ 37	/
QUM 40	42x42	37	38 Lt	STVQ 42	SVQR 39
QUM 45/4	47x47	40	56 Lt	STVQ 51	SVQR 42
QUM 50	50x50	50	77 Lt	STVQ 51	/
QUM 60	62x62	40	82 Lt	STVQ 69	/

Colori
Colors

99

Specifiche tecniche
Technical specifications



Lombardia

Vaso a parete
PMI



Codice Code				
PMI 40/4	47x32	40	27 Lt	STVD 42

Colori
Colors

99

Specifiche tecniche
Technical specifications





Collezione Country

Country
collection

78

RAGUSA
Campana
CMRO 40

77

LECCE
Ciotola
CTLEC 40

77

LECCE
Ciotola
CTLEC 40

78

RAGUSA
Campana
CMRO 40

77

RAGUSA
Cassetta ovale
CASTOR 46



Ragusa

Campana
CMRO

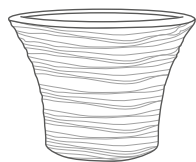

Codice
Code



CMRO 40

40

30

13 Lt

NSTVC 24

CMRO 50

50

38

28 Lt

NSTVC 32

Colori
Colors

77

78

Specifiche tecniche
Technical specifications



Lecce

Ciotola
CTLEC

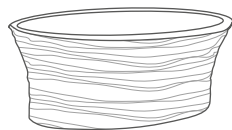

Codice
Code



CTLEC 40

40

17

9 Lt

NSTVC 32

Colori
Colors

77

Specifiche tecniche
Technical specifications



Ragusa

Cassetta ovale
CASTOR

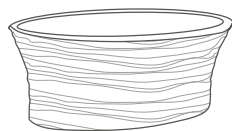

Codice
Code



CASTOR 46

46x26

19

7 Lt

SVOR 40

Colori
Colors

77

78

Specifiche tecniche
Technical specifications



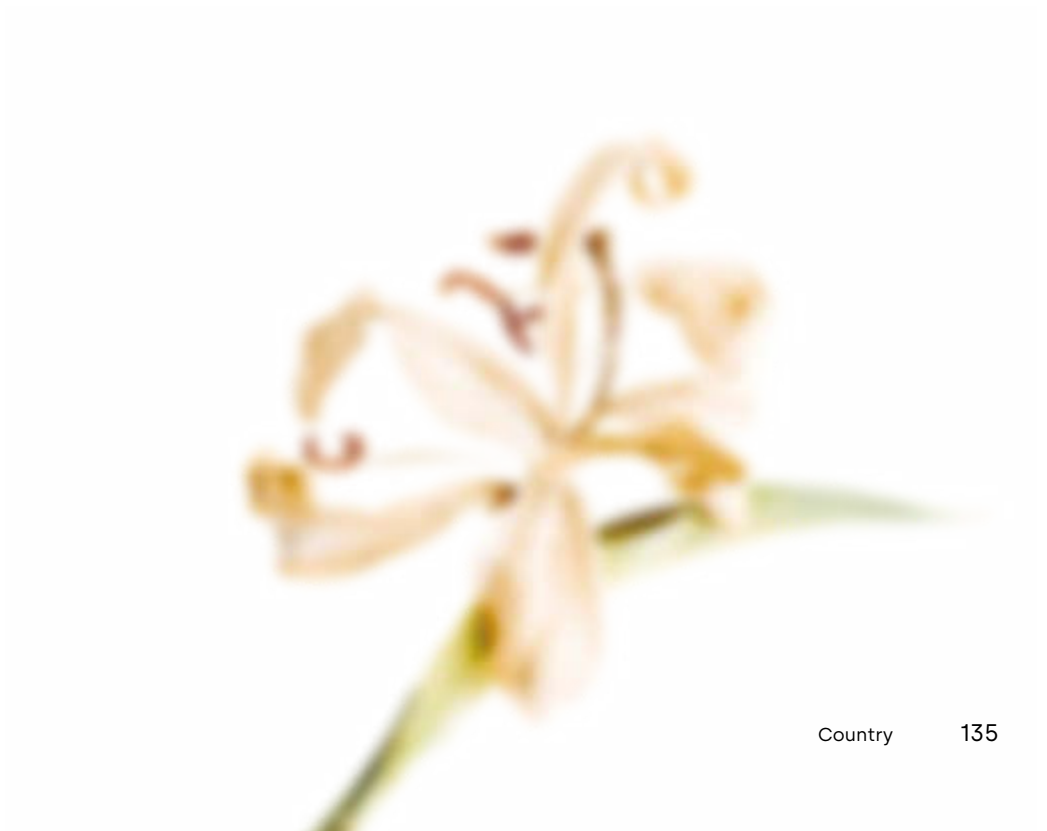

Collezione Impero

Impero
collection



99

EGNAZIA
Calice
CALEG 40

99

TROPEA
Campana
CNFA 40



BI

ROMA
Calice
CAFE 49



99

SALERNO
Gerla a muro
PFSA 21

99

FRIULI
Vaso a parete
PFRI 40



99

LAZIO
Cassetta
CFE 80

99

LAGO DI COMO
Cubo
QUCO 50

99

TROPEA
Campana
CNFA 78

Tropea

Campana
CNFA



Codice Code				
CNFA 25	25	20	3 Lt	NSTVC 16
CNFA 30	30	25	5 Lt	NSTVC 18
CNFA 35	35	29	9 Lt	NSTVC 20
CNFA 40	40	34	15 Lt	NSTVC 22
CNFA 45	44	37	25 Lt	NSTVC 26
CNFA 50	50	41	28 Lt	NSTVC 28
CNFA 56	53	45	36 Lt	NSTVC 32
CNFA 67	66	52	61 Lt	NSTVC 38
CNFA 72	71	56	77 Lt	NSTVC 40
CNFA 78	77	62	102 Lt	NSTVC 44
CNFA 95	95	77	215 Lt	NSTVC 54

Colori
Colors

99

Specifiche tecniche
Technical specifications



Egnazia

Calice
CALEG



Codice Code				
CALEG 40	40	46	23 Lt	SVQR 25

Colori
Colors

99

Specifiche tecniche
Technical specifications



Roma

Calice
CAFE



Codice Code			
CAFE 40	40	47	14 Lt
CAFE 49	49	57	25 Lt

Colori
Colors

BI

Specifiche tecniche
Technical specifications



Lazio

Cassetta
CRI

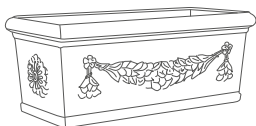

Codice Code					
CFE 50	50x23	20	11 Lt	/	SVRR 48
CFE 60	60x28	24	21 Lt	STVR 57	SVRR 58
CFE 80	80x36	33	42 Lt	STVR 75	SVRR 75
CFE 100	100x45	40	83 Lt	STVR 95	SVRR 92

Colori
Colors

99

Specifiche tecniche
Technical specifications



Lago di como

Cubo
QUCO

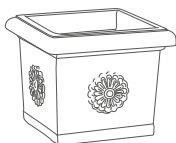

Codice Code					
QUCO 40	40x40	34	25 Lt	STVQ 37	/
QUCO 50	49x49	41	47 Lt	STVQ 42	SVQR 39

Colori
Colors

99

Specifiche tecniche
Technical specifications



Friuli

Vaso a parete
PFRI



Codice Code					
PFRI 40		41x25	40	19 Lt	SVPR 40
PFRI 53		54x33	53	45 Lt	SVPR 55

Colori
Colors

99

Specifiche tecniche
Technical specifications



Salerno

Gerla a muro
PFSA



Codice Code			
PFSA 21			31x18 21 3 Lt

Colori
Colors

99

Specifiche tecniche
Technical specifications



MOOD ABOUT
COLLECTIONS

Sfumature classiche

Classical nuances

Forme classiche si trasformano, trovando freschezza in contesti vibranti. Elementi e linee essenziali evocano una raffinatezza senza tempo, arricchita da tonalità e contrasti che rinnovano la tradizione. Una rilettura contemporanea che dà vita ad eleganti equilibri tra passato e presente.

Classic forms are reimagined, finding freshness in vibrant settings. Essential elements and lines evoke a timeless sophistication, enriched by tones and contrasts that renew tradition. A contemporary reinterpretation that brings to life elegant balances between past and present.

COLLECTIONS

Agrigento

Classico impruneta

Nastro



Collezione Agrigento

Agrigento
collection



F1

AGRIGENTO
Cilindro
CIPO 50

F1

AGRIGENTO
Cilindro
CIPOH 55

F1

AGRIGENTO
Ciotola
CTPO 56

F1

AGRIGENTO
Cassetta
CAPOR 80

F1

AGRIGENTO
Cubo
QUPO 35

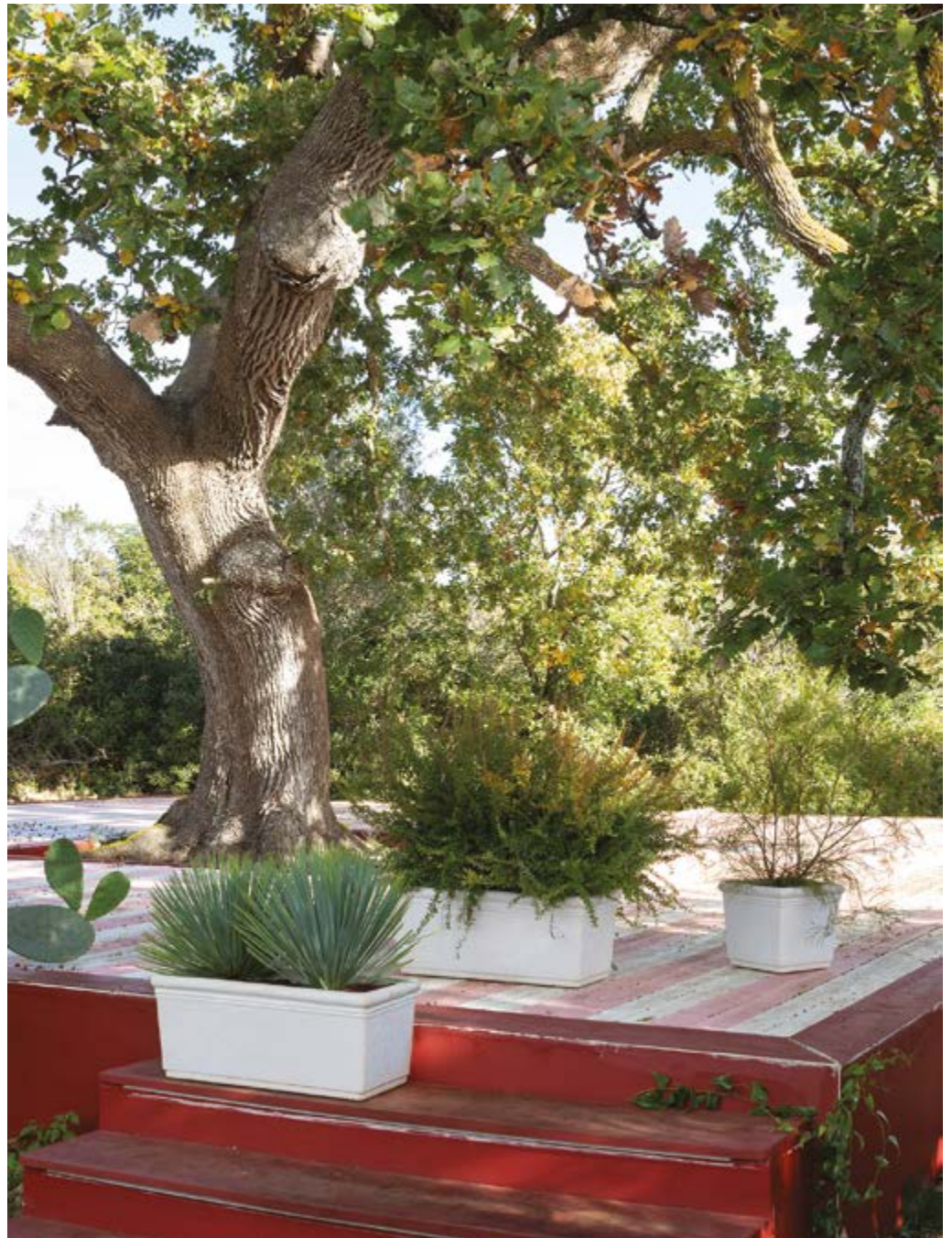

Agrigento

Cilindro
CIPO



Codice
Code



CIPO 50

50

37

46 Lt

NSTVC 42

Colori
Colors

F1

Specifiche tecniche
Technical specifications



Agrigento

Cilindro
CIPOH



Codice
Code



CIPOH 55

50

55

76 Lt

NSTVC 42

Colori
Colors

F1

Specifiche tecniche
Technical specifications



Agrigento

Ciotola
CTPO

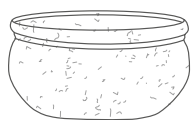

Codice
Code



CTPO 56

56

28

44 Lt

NSTVC 42

Colori
Colors

F1

Specifiche tecniche
Technical specifications



Agrigento

Cassetta
CAPOR

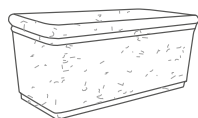

Codice
Code



CAPOR 80

80x35

33

56 Lt

CAPOR 100

100x43

40

110 Lt

Colori
Colors

F1

Specifiche tecniche
Technical specifications



Agrigento

Cubo
QUPO



Codice
Code



QUPO 35

35x35

33

24 Lt

QUPO 45

45x45

41

52 Lt

Colori
Colors

F1

Specifiche tecniche
Technical specifications





Collezione Classico impruneta

Classico
impruneta
collection

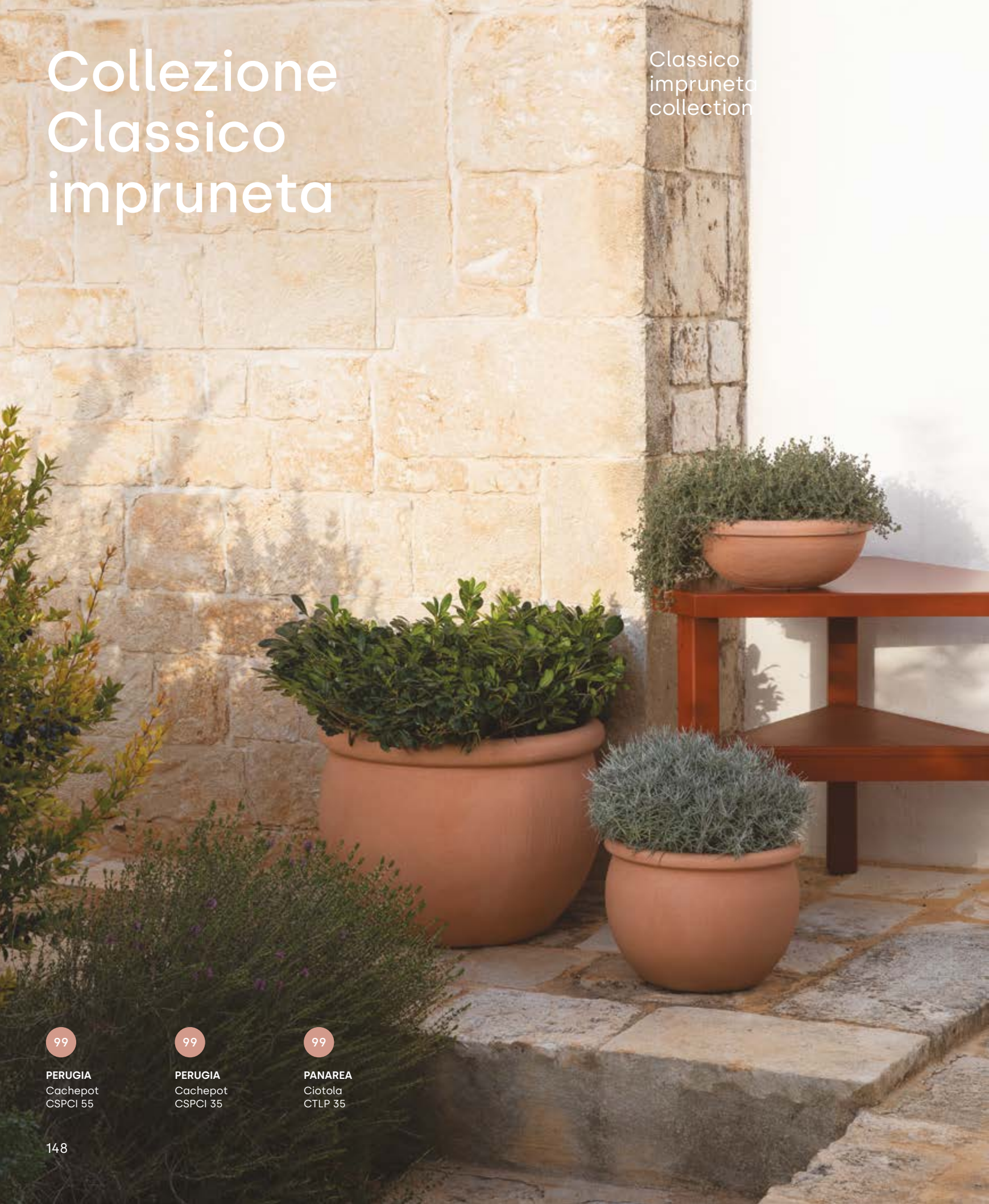

99

PERUGIA
Cachepot
CSPCI 55

99

PERUGIA
Cachepot
CSPCI 35

99

PANAREA
Ciotola
CTLP 35

99

SORRENTO
Cilindro
CISO 50

99

JESOLO
Campana
CMDB 60

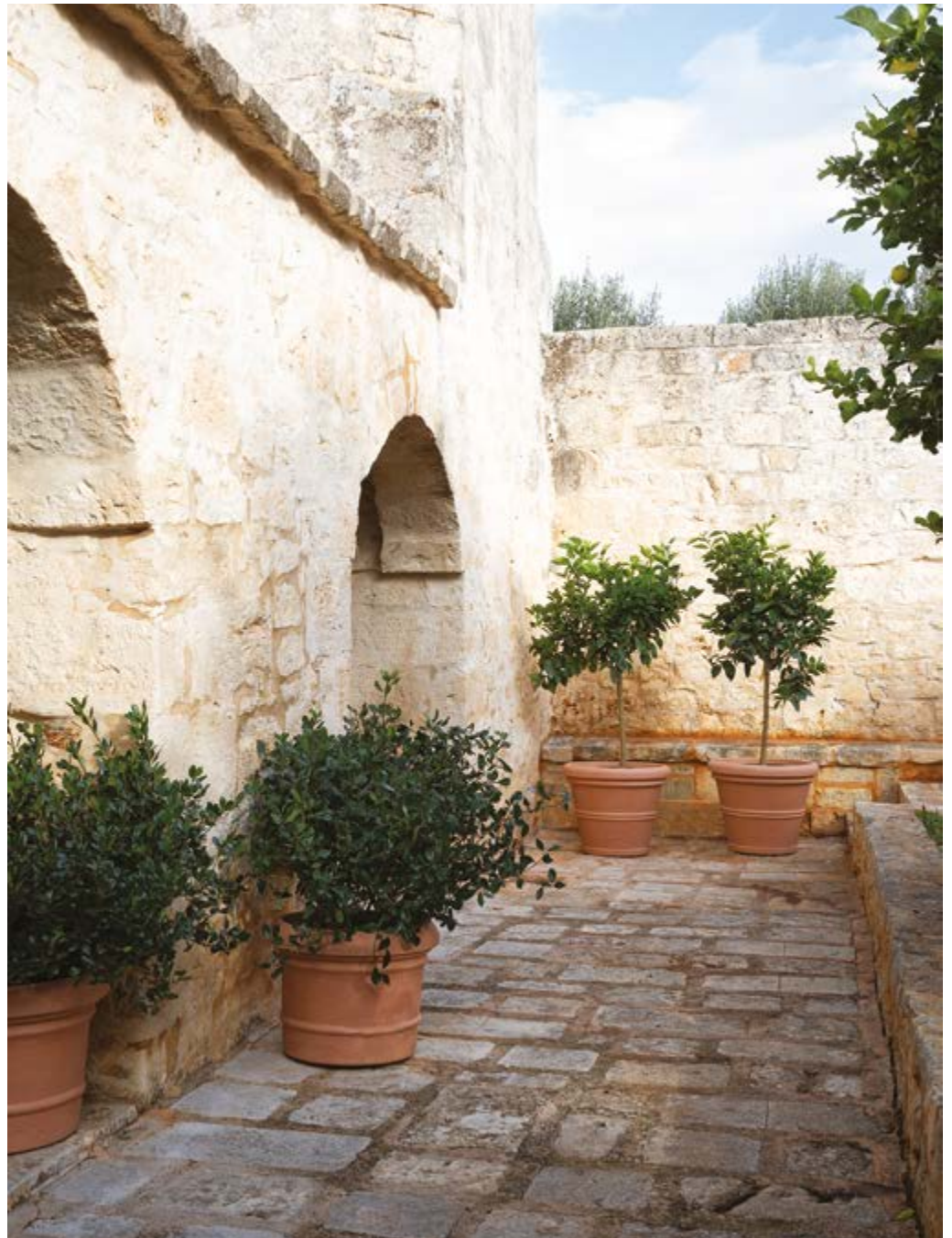

Sorrento

Cilindro
CISO



Codice Code				
CISO 30	30	23	7 Lt	NSTVC 22
CISO 35	35	27	11 Lt	NSTVC 26
CISO 40	40	30	17 Lt	NSTVC 30
CISO 45	45	34	25 Lt	NSTVC 34
CISO 50	50	38	36 Lt	NSTVC 38
CISO 60	60	45	60 Lt	NSTVC 46
CISO 70	70	52	100 Lt	NSTVC 52

Colori
Colors

99

Specifiche tecniche
Technical specifications



Jesolo

Campana
CMDB

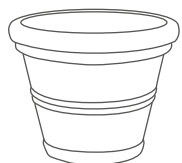

Codice Code				
CMDB 20	20	17	2 Lt	/
CMDB 25	25	21	3 Lt	NSTVC 16
CMDB 30	30	24	5 Lt	NSTVC 18
CMDB 35	35	28	10 Lt	NSTVC 22
CMDB 40	40	33	14 Lt	NSTVC 24
CMDB 45	45	37	23 Lt	NSTVC 28
CMDB 50	50	41	30 Lt	NSTVC 30
CMDB 55	55	45	42 Lt	NSTVC 34
CMDB 60	60	49	54 Lt	NSTVC 36
CMDB 70	70	56	82 Lt	NSTVC 42
CMDB 80	80	65	140 Lt	NSTVC 48
CMDB 95	95	77	233 Lt	NSTVC 58
CMDB 110	110	86	336 Lt	/
CMDB 135	135	90	505 Lt	/
CMDB 155	155	102	805 Lt	/

Colori
Colors

99

Specifiche tecniche
Technical specifications



Panarea

Ciotola
CTLP



Codice Code				
CTLP 35	35	14	5 Lt	NSTVC 22
CTLP 45	45	18	8 Lt	NSTVC 26
CTLP 55	55	22	17 Lt	NSTVC 32
CTLP 65	65	24	23 Lt	NSTVC 38
CTLP 75	75	29	32 Lt	NSTVC 44
CTLP 85	85	31	74 Lt	NSTVC 48
Colori Colors				77 99
Specifiche tecniche Technical specifications				

Perugia

Cachepot
CSPCI

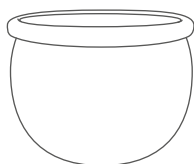

Codice Code				
CSPCI 35	35	27	18 Lt	NSTVC 24
CSPCI 45	45	34	38 Lt	NSTVC 30
CSPCI 55	55	42	67 Lt	NSTVC 36
Colori Colors				77 99
Specifiche tecniche Technical specifications				

Collezione Nastro

Nastro
collection



99

PORTO ROSA
Campada
CMFL 45

77

CHIETI
Tronco conico
COFA 50

I

CHIETI
Tronco conico
COFA 30





CHIETI
Tronco conico
COFA 30

77

CHIETI
Tronco conico
COFA 40

77

PORTO ROSA
Campada
CMFL 35



Porto rosa

Campada
CMFL



Codice Code				
CMFL 25	25	23	4 Lt	/
CMFL 35	35	30	12 Lt	NSTVC 18
CMFL 40	40	34	17 Lt	NSTVC 22
CMFL 45	45	38	21 Lt	NSTVC 24
CMFL 55	55	45	38 Lt	NSTVC 30
Colori Colors				
Specifiche tecniche Technical specifications				

Chieti

Tronco conico
COFA



Codice Code				
COFA 30	30	46	15 Lt	NSTVC 18
COFA 40	40	62	37 Lt	NSTVC 24
COFA 50	50	77	79 Lt	NSTVC 30
Colori Colors				
Specifiche tecniche Technical specifications				



Conchino | Round pot



CONCORD
Bali
p. 58



CLSB
Leviga
p. 114



CSL
Leviga
p. 117



CORI
Shabby
p. 26



BCA
Bubble
p. 68



BCI
Bubble
p. 68



CTGU
Gaudi
p. 64



CONCAN
Bambù
p. 38

Cilindro | Cylinder



CILBOU
Bouclé
p. 42



SACCO
Trame
p. 48



TICIL
Trame
p. 48

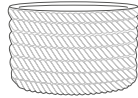

CILCORD
Bali
p. 59



CILAR
Ardesia
p. 78



CLRG
City
p. 84



CIPO
Agrigento
p. 145



CIPOH
Agrigento
p. 145



CISO
Classico impruneta
p. 149

Campana | Bell-shaped pot



CMHA
Shabby
p. 24



CMFS
Tonda
p. 111



CMFB
Tonda
p. 111



CMRO
Country
p. 132



CNFA
Impero
p. 136



CMDB
Classico impruneta
p. 149



CMFL
Nastro
p. 152

Ciotola | Bowl



CTPO
Agrigento
p. 145



CTLP
Classico impruneta
p. 148



CIOCORD
Bali
p. 56



CTFS
Shabby
p. 27



CSLT
Leviga
p. 114



CTLEC
Country
p. 132

Sfera | Sphere



SFERCORD
Bali
p. 59

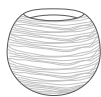

SFRI
Shabby
p. 24

Calice | Goblet



CALEG
Impero
p. 136



CAFE
Impero
p. 137

Cachepot | Cachepot



VSGU 45
Gaudi
p. 64



VSGU 55
Gaudi
p. 64



VSLC
Tonda
p. 110



CSPBO
Crespia
p. 120



CSPCI
Classico impruneta
p. 148

Tronco conico | Truncated cone



COMP
Tonda
p. 108



COFA
Nastro
p. 153



TBRI
Shabby
p. 25



TROBB
Crespia
p. 120



TROCO
Leviga
p. 114



PRIBO
Crespia
p. 123



PRICO
Quadra
p. 100

Portavaso | Tall pot with insert

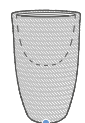

BOMCORD
Bali
p. 56



COSY PV
Shabby
p. 31

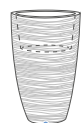

TCRI PV
Shabby
p. 24

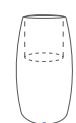

BFU PV
Bubble
p. 68



CILAR PV
Ardesia
p. 80



CLRG PV
City
p. 85



CNS PV
Tonda
p. 108

Portavaso quadro | Square tall pot with insert



PIL PV
Shabby
p. 24



CUBLA PV
Ardesia
p. 79

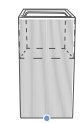

CURG PV
City
p. 84

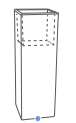

LTR PV
Quadra
p. 97

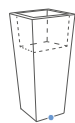

QNS PV
Quadra
p. 101

Cassetta ovale | Oval planter



CSGU
Gaudi
p. 65



COVGL
Crespia
p. 120

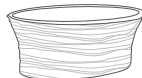

CASTOR
Country
p. 133

Cassetta | Planter



CATRI
Shabby
p. 31

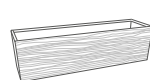

BASY
Shabby
p. 31

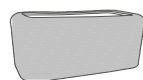

CASCORD
Bali
p. 59



CATLA
Ardesia
p. 78



CSRG
City
p. 87

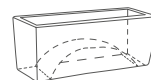

CATL XL
Quadra
p. 99

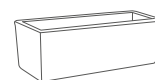

CATL B
Quadra
p. 97



BATL
Quadra
p. 99

Cassetta | Planter

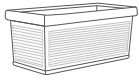

CRI
Lombardia
p. 128



CFE
Impero
p. 139



CAPOR
Agrigento
p. 145

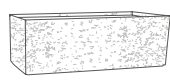

CASBOU
Bouclé
p. 46

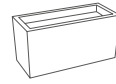

CASLINEA
Linea
p. 90

Cassetta alta | Tall planter

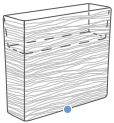

CASR PV
Shabby
p. 31

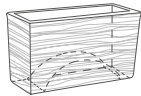

CATLR
Shabby
p. 31

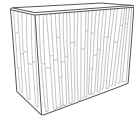

CANTL
Bambù
p. 38

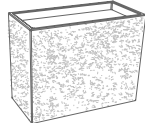

CASHBOU
Bouclé
p. 46

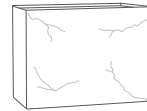

CATLH
Ardesia
p. 78

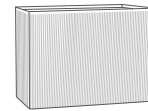

CSRGH
City
p. 87

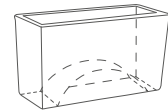

CATL
Quadra
p. 97

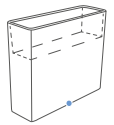

CSTS PV
Quadra
p. 103

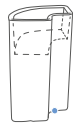

VNS PV
Quadra
p. 103

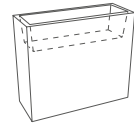

CASLINEA PV
Linea
p. 90

Cubo | Box

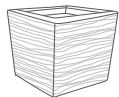

CUBRI
Shabby
p. 25

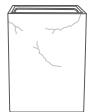

CUBLA
Ardesia
p. 79



CUBLA B
Ardesia
p. 79



CURG
City
p. 87

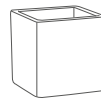

CUBL
Quadra
p. 97



QUPO
Agrigento
p. 145

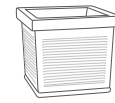

QUM
Lombardia
p. 128



QUCO
Impero
p. 139

Vaso a parete | Wall pot



VALPO
Tonda
p. 109



PFRI
Impero
p. 138



PMI
Lombardia
p. 128



VALMO
Tonda
p. 109

Vaso angolare | Corner pot

Vaso urbano | Urban pot



ACACORD
Bali
p. 57



ACAYA
Acaya
p. 73



ACASHAB
Shabby
p. 33



ACABOU
Bouclé
p. 46

Gerla a muro | Wall basket



GERSY
Shabby
p. 29



PFSA
Impero
p. 138

Vaso pensile | Hanging basket



VPBSH
Shabby
p. 29



VPCL
Crespia
p. 121

Orcio | Urn



VCSD
Leviga
p. 116

Serbatoio acqua piovana | Rainbarrel



RAIN
Shabby
p. 28

Colori linea Class

Class line colors

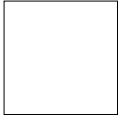

BI
Bianco

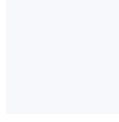

NE
Neutro



GH
Ghisa

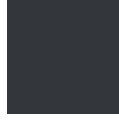

I
Smoke



PH
Graphite



QZ
Quarzo



71
Cool grey



55
Industrial grey



GD
Giada



DW
Dark wood



BW
Brown



78
Tortora



FA
Fango



F1
Tufo



67
Corda

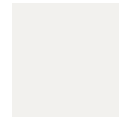

77
Bianco perla



46
Nomade



97
Cipria



OG
Oxford green



99
Impruneta



56
Senape



95
Avio



91
Polvere



S3
Clay



VV
Verde



DE
Desert



LV
Grigio lava



B3
Carbon

Texture linea Class

Class line textures



Shabby
(67 - Corda)

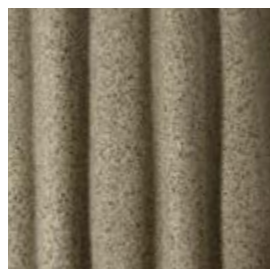

Bambù
(OG - Oxford green)

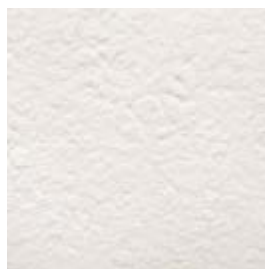

Bouclé
(77 - Bianco perla)



Trame
(67 - Corda)



Bali
(GD - Giada)



Ardesia
(55 - Industrial grey)



City
(46 - Nomade)



**Linea - Quadra - Tonda
Leviga**
(I - Smoke)



Crespia
(78 - Tortora)

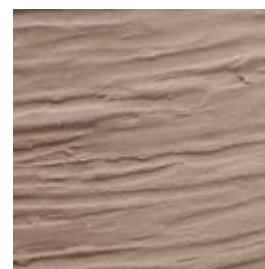

Country
(78 - Tortora)

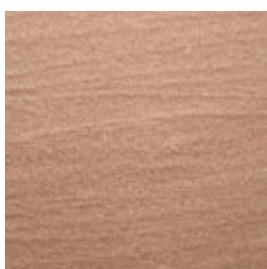

Impero
(99 - Impruneta)



Agrigento
(F1 - Tufo)

Novità

News

Rimani sempre aggiornato sui nuovi colori e le nuove texture Vasar, inquadra il QR code per vedere se ci sono state modifiche

Stay up to date on Vasar new colors and new textures, scan the QR code to see if there have been any changes

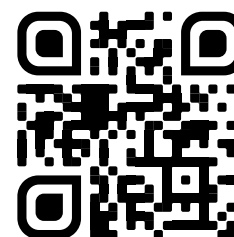

Ingombri | Overall dimensions



**larghezza/
diametro**
width/
diameter



altezza
height



capacità Lt
capacity Lt



**altezza
portavaso**
depth



**diametro
portavaso**
diameter

Sottovasi | Saucers



sottovaso
drainage
saucer
(fig.1)



**sottovaso
con rialzo**
saucer with
elevation
(fig.2)

Specifiche tecniche | Technical specifications

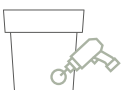

**fori
predisposti**
holes to be
drilled
(fig.3)

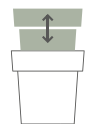

**contenitore
estraibile**
removable
container
(fig.4)



**portavaso con
sottotappo**
pot with
insert and lid
(fig.5)



**portavaso con
sottotappo
e sistema di
drenaggio**
pot with
insert, lid and
drainage system
(fig.6)



tappo a vite
screw cap
(fig.7)



rubinetto
tap
(fig.8)

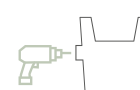

**zona piana per
collegamento
pluviale**
flat area for
rainwater
connection
(fig.9)

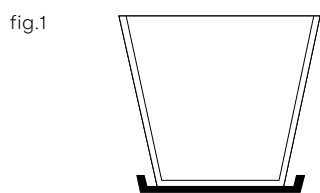

sottovaso
drainage
saucer

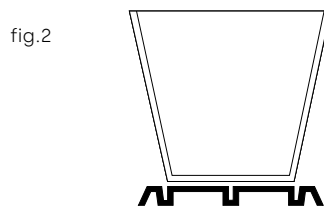

**sottovaso
con rialzo**
saucer with
elevation

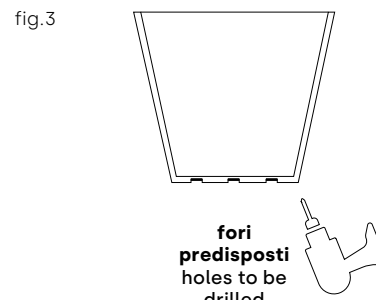

**fori
predisposti**
holes to be
drilled

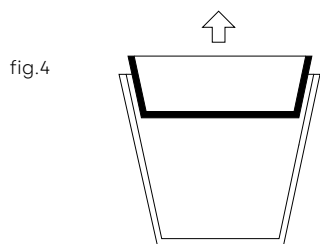

**contenitore
estraibile**
removable
container

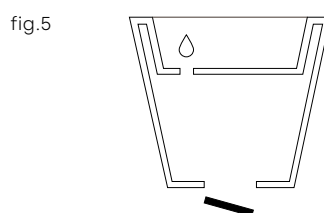

**portavaso con
sottotappo**
pot with
insert and lid

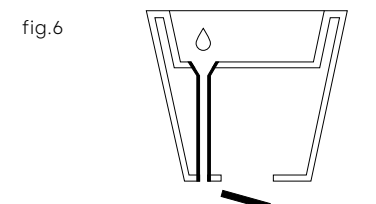

**portavaso con sottotappo
e sistema di drenaggio**
pot with insert,
lid and drainage system

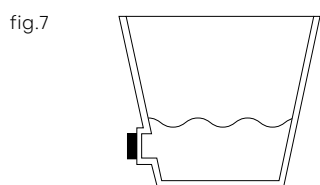

tappo a vite
screw cap

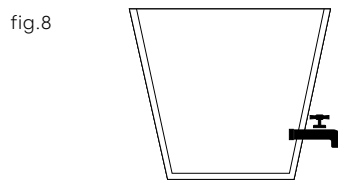

rubinetto
tap

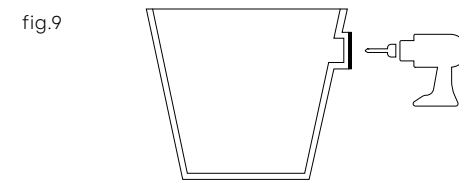

**zona piana per
collegamento pluviale**
flat area for rainwater
connection

Thanks to

Vogliamo ringraziare i luoghi e le persone che hanno reso possibile la realizzazione di questo catalogo:

We want to thank the places and people who have made possible the realization of this catalogue:

Strutture

- Masseria Lamacoppa - Ostuni (BR);
- Masseria Santo Scalone - Ostuni (BR)
- Tenuta Parco Paolino - Ostuni (BR)
- Residenza Privata Trulli Amore - Ostuni (BR)
- WTH Studio - Ponte San Nicolò (PD)

Vivai

- Pinto Nicola Florovivaistica – Locorotondo (BA)
- Floricoltura Cavinato di Cavinato Patrizia - San Giorgio delle Pertiche (PD)
- Floricoltura Briantea - Bellusco (MB)

Copyright © 2025

Art direction

Nui Design s.r.l.s.

Graphic design

Nui Design s.r.l.s.

Photos

Filippo Bamberghi

Styling

Sissi Valassina

Images (unsplash.com)

Aarn Giri - p. 2

Thomas Vogel - p. 10

Claudia Sommer - p. 16

Priscilla Fraire - Copertina

Copywriting

Alessandro Rea

Tutti i diritti riservati.

È vietata ogni forma di utilizzo e riproduzione del materiale testuale, grafico e fotografico ivi contenuto.

I dati e i colori riportati in questo catalogo sono indicativi.

Telcom si riserva il diritto di apportare eventuali variazioni o miglie a gli articoli illustrati senza preavviso.

I nostri uffici commerciali rimangono a vostra completa disposizione per qualsiasi ulteriore delucidazione.

Misure espresse in centimetri, tolleranza +/- 1.5 %.

Information and colors in our catalogue are just indicative.

Telcom reserves the right to effect any changes or improvements to the illustrated articles, without notice.

For any further information our sales departments are at your complete disposal.

Measures are expressed in centimeters, tolerance +/- 1.5%.

Telecom[®]

vašar
ITALIAN GARDEN DESIGN

modum

Jolly
by Telecom

AQUARIUS[®]
by Telecom
SERBATOI PER ACQUA POTABILE

eco[®]
AQUARIUS[®]
PROGETTATI PER RISPETTARE L'AMBIENTE

Buddy[®]
by Telecom

Le Giare

Abruzzo
Vasi[®]
by Telecom Group





Telcom Spa

Via dell'Industria, 21
72017 Ostuni (BR) Italy
Tel. +39 0831 348 111 r.a.
Fax +39 0831 304 510

telcom@telcomitalia.it
telcom@legalmail.it

www.telcomitalia.it

Telcom[®]