



Catalogo 2025

LINEA CLASS

2025

.01

---



Catalogo  
CLASS

Tecnologia  
di stampaggio  
rotazionale

Rotational  
molding  
technology

.02

---

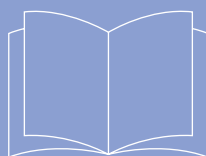

Catalogo  
FLOW

Tecnologia  
di stampaggio  
ad iniezione

Injection  
molding  
technology

.03

---



Listino  
prezzi

Class,  
Flow,  
Esplorando

Class,  
Flow,  
Esplorando

# Index

## 0 INDICE PER COLLEZIONE

INDEX BY COLLECTION

p. 4

## 1 INTRODUZIONE

INTRODUCTION

**Azienda** Company p. 8

**Sostenibilità** Sustainability p. 10

**Tecnologia** Technology p. 14

**Vasar** Vasar p. 18

## 2 PRODOTTI

PRODUCTS

**Intrecci tattili** Touch-sensitive twists

**Shabby** p. 24

**Bambù** p. 38

**Bouclé** p. 42

**Trame** p. 48

**Sussurri marini** Sea waves whispers

**Bali** p. 56

**Tenui atmosfere** Warm atmospheres

**Gaudi** p. 64

**Bubble** p. 68

**Acaya** p. 72

**Frammenti urbani** Urban fragments

**Ardesia** p. 78

**City** p. 84

**Linea** p. 90

**Pura essenza** Purest essence

**Quadra** p. 96

**Tonda** p. 108

**Leviga** p. 114

**Crespia** p. 120

**Radici mediterranee** Mediterranean roots

**Lombardia** p. 128

**Country** p. 132

**Impero** p. 136

**Sfumature classiche** Classical nuances

**Agrigento** p. 144

**Classico impruneta** p. 148

**Nastro** p. 152

## 3 OVERVIEW

OVERVIEW

**Overview per tipologia** Overview by type p. 158

**Colori e texture** Colors and textures p. 162

**Legenda icone** Icons legend p. 164

## Shabby



CORI  
**Conchino**  
p. 26



CMHA  
**Campana**  
p. 24

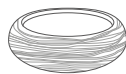

CTFS  
**Ciotola**  
p. 27

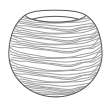

SFRI  
**Sfera**  
p. 24

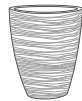

TBRI  
**Tronco conico**  
p. 25



TCRI PV  
**Portavaso**  
p. 25



COSY PV  
**Portavaso**  
p. 31



PIL PV  
**Portavaso quadro**  
p. 25

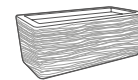

CATRI  
**Cassetta**  
p. 31



BASY  
**Cassetta**  
p. 31



CASR PV  
**Cassetta alta**  
p. 31

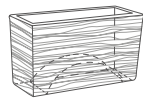

CATLR  
**Cassetta alta**  
p. 31

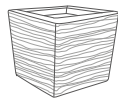

CUBRI  
**Cubo**  
p. 25



ACASHAB  
**Vaso urbano**  
p. 33



GERSY  
**Gerla a muro**  
p. 29



VPBSH  
**Vaso pensile**  
p. 29



RAIN  
**Serbatoio acqua  
piovana**  
p. 28

## Bambù



CONCAN  
**Conchino**  
p. 38

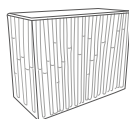

CANTL  
**Cassetta alta**  
p. 38

## Bouclé



CILBOU  
**Cilindro**  
p. 42



CASBOU  
**Cassetta**  
p. 46

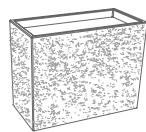

CASHBOU  
**Cassetta alta**  
p. 46

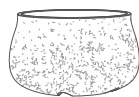

ACABOU  
**Vaso urbano**  
p. 46

## Trame



SACCO  
**Cilindro**  
p. 48



TICIL  
**Cilindro**  
p. 48

## Bali



CONCORD  
**Conchino**  
p. 56

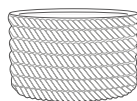

CILCORD  
**Cilindro**  
p. 59



CIOCORD  
**Ciotola**  
p. 56

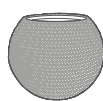

SFERCORD  
**Sfera**  
p. 59



BOMCORD  
**Portavaso**  
p. 56

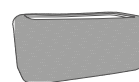

CASCORD  
**Cassetta**  
p. 59



ACACORD  
**Vaso urbano**  
p. 57

## Gaudi



CTGU  
**Conchino**  
p. 64



VSGU 45  
**Cachepot**  
p. 64



VSGU 55  
**Cachepot**  
p. 64



CSGU  
**Cassetta ovale**  
p. 65

## Bubble



BCA  
**Conchino**  
p. 68



BCI  
**Conchino**  
p. 68



BFU PV  
**Portvaso**  
p. 68

## Acaya



ACAYA  
**Acaya**  
p. 73

## Ardesia



CILAR  
**Cilindro**  
p. 78



CILAR PV  
**Portvaso**  
p. 80



CUBLA PV  
**Portvaso quadro**  
p. 79



CATLA  
**Cassetta**  
p. 78

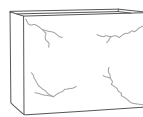

CATLH  
**Cassetta alta**  
p. 78



CUBLA  
**Cubo**  
p. 79



CUBLA B  
**Cubo**  
p. 79

## City



CLRG  
**Cilindro**  
p. 84



CLRG PV  
**Portvaso**  
p. 85



CURG PV  
**Portvaso quadro**  
p. 84

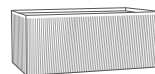

CSRG  
**Cassetta**  
p. 87

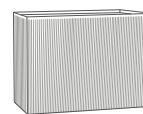

CSRGH  
**Cassetta alta**  
p. 87

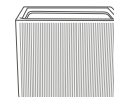

CURG  
**Cubo**  
p. 87

## Linea



CASLINEA  
**Cassetta**  
p. 90

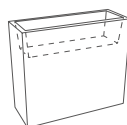

CASLINEA PV  
**Cassetta alta**  
p. 90

## Quadra



PRICO  
**Tronco conico**  
p. 100

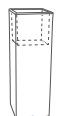

LTR PV  
**Portavaso quadro**  
p. 97

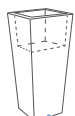

QNS PV  
**Portavaso quadro**  
p. 101

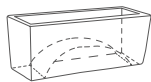

CATL XL  
**Cassetta**  
p. 99

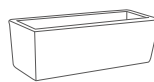

CATL B  
**Cassetta**  
p. 97

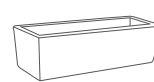

BATL  
**Cassetta**  
p. 99

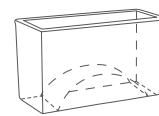

CATL  
**Cassetta alta**  
p. 97

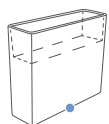

CSTS PV  
**Cassetta alta**  
p. 103

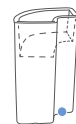

VNS PV  
**Cassetta alta**  
p. 103

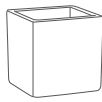

CUBL  
**Cubo**  
p. 97

## Tonda



CMFS  
**Campana**  
p. 111



CMFB  
**Campana**  
p. 111



VSLC  
**Cachepot**  
p. 110



COMP  
**Tronco conico**  
p. 108



CNS PV  
**Portavaso**  
p. 108



VALPO  
**Vaso a parete**  
p. 109



VALMO  
**Vaso angolare**  
p. 109

## Leviga



CLSB  
**Conchino**  
p. 114



CSL  
**Conchino**  
p. 117



CSLT  
**Ciotola**  
p. 114



TROCO  
**Tronco conico**  
p. 114



VCSD  
**Orcio**  
p. 116

## Crespia



CSPBO  
**Cachepot**  
p. 120



TROBB  
**Tronco conico**  
p. 120



PRIBO  
**Tronco conico**  
p. 123



COVGL  
**Cassetta ovale**  
p. 120



VPCL  
**Vaso pensile**  
p. 121

## Lombardia

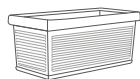

CRI  
**Cassetta**  
p. 128

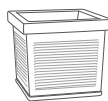

QUM  
**Cubo**  
p. 128



PMI  
**Vaso a parete**  
p. 128

## Country



CMRO  
**Campana**  
p. 132



CTLEC  
**Ciotola**  
p. 132



CASTOR  
**Cassetta ovale**  
p. 133

## Impero



CNFA  
**Campana**  
p. 136



CALEG  
**Calice**  
p. 136



CAFE  
**Calice**  
p. 137

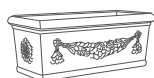

CFE  
**Cassetta**  
p. 139



QUCO  
**Cubo**  
p. 139



PFRI  
**Vaso a parete**  
p. 138



PFSA  
**Gerla a muro**  
p. 138

## Agrigento



CIPO  
**Cilindro**  
p. 145



CIPOH  
**Cilindro**  
p. 145



CTPO  
**Ciotola**  
p. 145

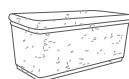

CAPOR  
**Cassetta**  
p. 145



QUPO  
**Cubo**  
p. 145

## Classico impruneta



CISO  
**Cilindro**  
p. 149



CMDB  
**Campana**  
p. 149



CTLP  
**Ciotola**  
p. 148



CSPCI  
**Cachepot**  
p. 148

## Nastro



CMFL  
**Campana**  
p. 152



COFA  
**Tronco conico**  
p. 153



# Telcom, l'azienda

Telcom,  
the company

La Telcom SPA si distingue per lo sviluppo di prodotti innovativi realizzati in materie termoplastiche, che contribuiscono in vario modo a migliorare la qualità della vita di chi li utilizza, unendo design italiano, solidità e funzionalità.

Telcom Spa is distinguished by the development of innovative products made of thermoplastics, which contribute in various ways to improve the quality of life of users, combining Italian design, strength and functionality.



Creiamo prodotti seguendo i principi di qualità e rispetto dell'ambiente, e lo facciamo da più di cinquant'anni.

We create products by following the principles of quality and respect of the environment, and we do it for more than fifty years.

110.000 m2 di strutture aziendali su tre sedi

110.000 m2 premises on three factories

8 brand di proprietà Telcom

8 brands own by Telcom

3 sedi in Italia, Romania, Albania

3 branches in Italy, Romania, Albania



Telcom  
company profile

Processi produttivi integrati in azienda

Fully integrated production processes

# Design per un futuro sostenibile

Design for a  
sustainable future

Telcom si impegna per la sostenibilità, garantendo che i suoi prodotti abbiano un impatto ambientale minimo. Vogliamo dare nuova vita alla plastica e ridurre l'impatto delle nostre attività sull'ambiente. Per questo pensiamo alla sostenibilità, in tutto ciò che facciamo. Scopri i nostri prodotti.

Telcom is committed to sustainability, ensuring that its products have minimal environmental impact. We want to give new life to plastics and reduce the impact of our activities on the environment. That is why we think about sustainability, in everything we do. Discover our products.

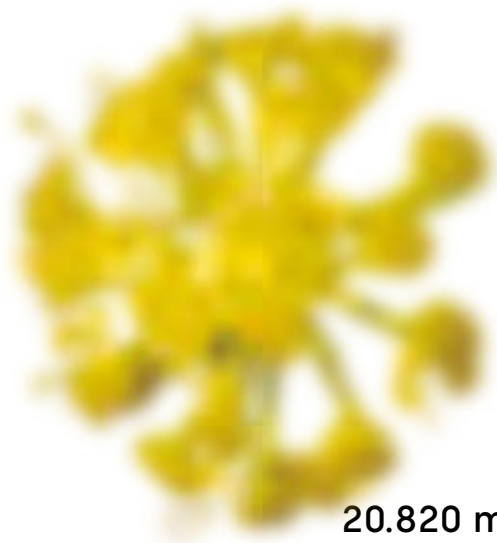

**20.820 m<sup>2</sup>  
di pannelli fotovoltaici  
sul territorio nazionale**

20.820 m<sup>2</sup> of photovoltaic  
panels on the national territory

**2088 ton di CO<sub>2</sub>  
risparmiata in  
media all'anno**

2088 tons of CO<sub>2</sub> saved  
in average per year

**3.031.000 KW/h di  
energia pulita e  
rinnovabile all'anno**

3.031.000 KW/h of clean and  
renewable energy per year

**Quantità sempre  
maggiore di plastica  
riciclata nelle collezioni**

Use of an ever-increasing quantity of  
recycled plastic in our collections

**Tutti i prodotti sono  
realizzati in materiale  
100% riciclabile**

All products are made of  
100% recyclable material

**Riciclo al nostro  
interno di acqua e  
scarti di produzione**

Recycling of water and  
production waste in-house

---

**MATERIALE**

**Il colore Carbon è prodotto con  
materia prima 100% riciclata**

**MATERIAL**

The Carbon color is made from  
100% recycled raw material

# Più di semplici certificazioni: una missione

More than simple  
certifications:  
it is a mission

## Agenda 2030: gli Obiettivi di Sviluppo Sostenibile già raggiunti

Agenda 2030: the Sustainable  
Development Goals we have  
already reached

**Obiettivo 3:**  
Salute e benessere

Goal 3: Good health  
and well-being

**Obiettivo 5:**  
Uguaglianza di  
genere

Goal 5:  
Gender equality

**Obiettivo 6:**  
Acqua pulita e igiene

Goal 6: Clean water  
and sanitation

**Obiettivo 8:**  
Lavoro dignitoso e  
crescita economica

Goal 8:  
Decent work and  
economic growth

**Obiettivo 9:**  
Imprese, innovazione  
e infrastrutture

Goal 9: Industry,  
innovation and  
infrastructure

**Obiettivo 10:**  
Ridurre le  
disuguaglianze

Goal 10:  
Reduced  
inequalities

**Obiettivo 12:**  
Consumo e  
produzione  
responsabili

Goal 12:  
Responsible  
consumption  
and production

**Obiettivo 13:**  
Lotta contro il  
cambiamento  
climatico

Goal 13:  
Climate  
action

**Obiettivo 15:**  
Vita sulla Terra

Goal 15:  
Life on Land



## Operatore economico autorizzato

Authorised  
economic  
operator



## Gestione qualità

Quality  
management



## Gestione ambientale

Environmental  
management



## Gestione della salute e sicurezza sul lavoro

Management  
of health and  
safety at work

Le certificazioni rappresentano per noi non solo un riconoscimento, ma anche uno strumento per misurare e migliorare costantemente il nostro impatto. Siamo impegnati a trasformare i nostri principi in azioni concrete, per un equilibrio tra innovazione, rispetto per l'ambiente e benessere delle persone.

Certifications are not only a recognition for us, but also a tool to measure and constantly improve our impact. We are committed to translating our principles into concrete actions, for a balance between innovation, respect for the environment and people well-being.

# Un impegno concreto verso l'uguaglianza di genere: la normativa UNI/PdR 125:2022

A concrete commitment towards gender equality: the UNI/PdR 125:2022

La parità di genere non è solo un valore, ma una responsabilità. Telcom S.p.A. è orgogliosa di essere certificata secondo la normativa UNI/PdR 125:2022, che testimonia il nostro impegno nel garantire un ambiente di lavoro inclusivo ed equo.

Gender equality is not only a value, but also a responsibility. Telcom S.p.A. is proud to be certified according to the UNI/PdR 125:2022 standard, which testifies our commitment to ensuring an inclusive and fair working environment.

## EQUITÀ E INCLUSIONE

Promuoviamo pari opportunità in tutte le fasi lavorative, dalla progettazione alla produzione.

## EQUITY AND INCLUSION

We promote equal opportunities in all the work stages, from design to production.

## VALORIZZAZIONE DEL TALENTO

Crediamo che ogni persona debba avere le stesse opportunità di crescere professionalmente, senza discriminazioni.

## ENHANCEMENT OF TALENT

We believe that everyone should have the same opportunities to grow professionally, without discrimination.

## RESPONSABILITÀ SOCIALE

Questa certificazione è il risultato del nostro impegno verso una cultura aziendale che valorizza il contributo di ogni individuo.

## SOCIAL RESPONSIBILITY

This certification is the result of our commitment to a corporate culture that values the contribution of each individual.



# Impegno per una produzione responsabile

Commitment to responsible production

## PROGETTAZIONE DESIGN



**Creatività e innovazione si uniscono nella linea Vasar: tecnologia CAD/CAM e design Made in Italy creano vasi unici, fondendo artigianato e precisione digitale, ispirati alla natura.**

Creativity and innovation come together in the Vasar line: CAD/CAM technology and Made in Italy design create unique pots, blending craftsmanship with digital precision, inspired by nature.

## STAMPAGGIO MOLDING



**Telcom utilizza tecnologie avanzate di stampaggio rotazionale e a iniezione per produrre la sua linea di vasi Vasar, garantendo una produzione di alta qualità e a basso impatto ambientale.**

Telcom utilizes advanced rotational and injection molding technologies to produce its Vasar line of planters, ensuring both high-quality and sustainable production.

## IMBALLAGGIO PACKAGING



Telcom si impegna per la sostenibilità con confezionamenti eco-green e materiali riciclabili a basso impatto ambientale. Ogni fase riduce l'impronta ecologica, esaltando il valore dei prodotti Vasar.

Telcom is committed to sustainability with eco-green packaging and recyclable, low environmental impact materials. Each phase minimizes the ecological footprint, highlighting the value of Vasar products.

## LOGISTICA LOGISTICS



La distribuzione di Telcom si basa su un'efficiente logistica e un magazzino di 40.000 mq automatizzato con il sistema LGV, grazie all'ausilio di sensori e connessioni wireless per il trasporto di prodotti finiti.

Telcom's distribution is based on efficient logistics and a 40,000 sqm automated warehouse supported by LGVs, using sensors and wireless connections to transport finished products.



# Telcom e la tecnologia rotazionale

Telcom and rotational technology

**Prestiamo particolare attenzione a ogni dettaglio, perché è proprio durante la fase di post-produzione e nella rifinitura manuale che ogni nostro manufatto prende vita. Ogni vaso, perfezionato con cura artigianale, si distingue per la sua unicità e per l'altissima qualità che lo contraddistingue.**

We pay close attention to every detail, as it is during the post-production phase and the meticulous finishing process that each of our creations comes to life. Each pot, refined with exceptional care, stands out for its uniqueness and outstanding quality.

---

01.	<b>2.000 articoli differenti con volume da 10 litri a 50.000 litri</b>	2,000 different articles with volumes from 10 liters to 50,000 liters
02.	<b>4.500 tonnellate di polietilene lavorate ogni anno</b>	4,500 tons of polyethylene processed every year
03.	<b>8 impianti avanzati di stampaggio rotazionale di diverse dimensioni</b>	8 advanced rotational molding plants of various sizes
04.	<b>Impianto produttivo innovativo che permette libertà nel design e nelle texture</b>	Innovative production facility that enables freedom in design and textures

---



# Vasar, in equilibrio tra innovazione e tradizione

Vasar, balancing  
innovation and  
tradition

Vasar è un modo per portare la bellezza naturale negli spazi quotidiani. Le nostre creazioni uniscono tradizione e innovazione, trovando l'equilibrio tra materiali e forme delicate, focalizzandosi su uno stile che si fonde naturalmente con qualsiasi ambiente.

Vasar is a way to bring natural beauty into everyday spaces. Our creations combine tradition and innovation, striking a balance between materials and delicate forms, focusing on a style that seamlessly blends with any environment.

# Un design che parla di stile e rispetto per la natura, rendendo ogni oggetto un'espressione delicata della sua bellezza.

A design that embodies style and respect for nature, making each piece a delicate expression of its beauty.

## 01. ELEGANZA SENZA TEMPO

**Le creazioni di Vasar vanno oltre le mode. Sono fatte per durare, per raccontare una storia di raffinatezza e calma, in perfetta armonia con lo spazio che le accoglie.**

## 01. TIMELESS ELEGANCE

Vasar's creations go beyond fashions. They are made to last, to tell a story of sophistication and calm, in perfect harmony with the space that welcomes them.

## 02. LA FORZA DELLA SEMPLICITÀ

**Con il suo design, Vasar celebra l'essenza della natura in modo universale. Ogni dettaglio evoca emozioni sincere, creando un legame tra spazi, culture e generazioni.**

## 02. THE POWER OF SIMPLICITY

With its design, Vasar celebrates the essence of nature in a universal way. Every detail evokes sincere emotions, creating a link between spaces, cultures and generations.

## 03. UN'ESTETICA DA VIVERE

**Le linee sono morbide e naturali, per creare un'estetica che invita a rilassarsi e apprezzare la semplicità delle forme pure.**

## 03. AN AESTHETICS TO BE EXPERIENCED

The lines are soft and natural, to create an aesthetic that invites you to relax and appreciate the simplicity of pure forms.

**Vogliamo creare connessioni  
autentiche tra le persone unite  
dalla passione per il garden, dove  
Vasar diventa punto d'incontro.**

We aim to create authentic  
connections among people  
united by their passion for  
gardening, where Vasar  
becomes a meeting point.

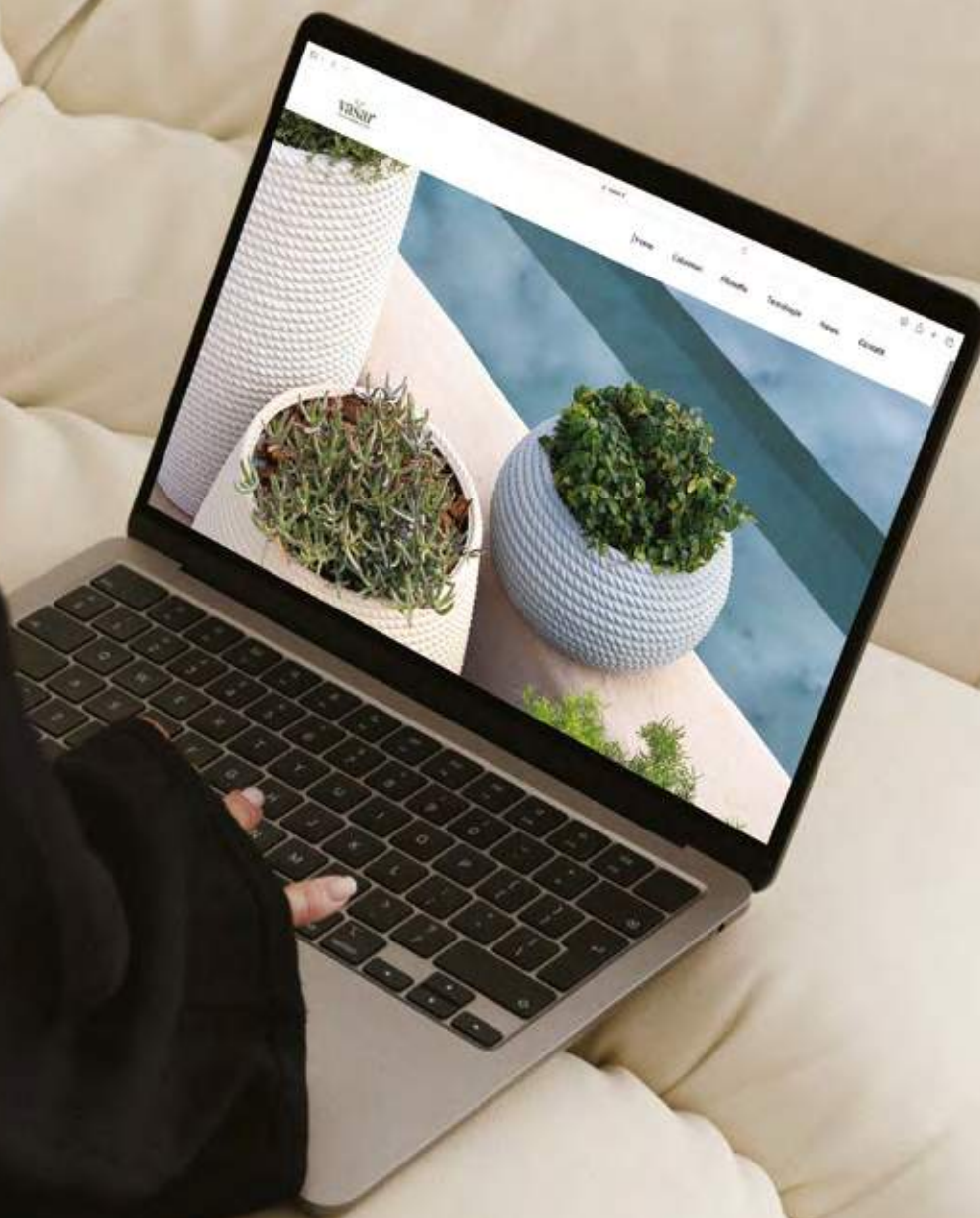

## NOVITÀ PRODOTTI

### NEW PRODUCTS

**All'interno delle nostre piattaforme digitali, potrete restare sempre aggiornati sulle ultime novità dei nostri prodotti, assicurandovi di non perdersi nulla.**

Within our digital platforms, you can stay constantly updated on the latest news about our products, ensuring you don't miss anything.

## CONSIGLI E IDEE

### TIPS AND IDEAS

**Amiamo condividere con voi consigli e suggerimenti sul mondo del garden, insieme ai trend e alle ultime novità del settore. E ovviamente amiamo ascoltare la vostra opinione e lasciarci ispirare.**

We love sharing tips and advice with you about the world of gardening, along with trends and the latest industry news. And of course, we love hearing your opinions and finding inspiration in them.

## EVENTI VASAR

### VASAR EVENTS

**Nel nostro sito troverete la sezione "Eventi", dove potrete scoprire tutte le date per incontrarci a fiere e giornate dedicate al mondo del garden.**

On our website, you'll find the "Events" section, where you can discover all the dates to meet us at trade fairs and days dedicated to the world of gardening.



Vasar website

 [vasar\\_telcom](#)

 [Vasar](#)

MOOD ABOUT  
COLLECTIONS

# Intrecci Tattili

Touch-sensitive twists

**La materia si rivela al tatto, trame intrecciate che esaltano la bellezza di ciò la natura crea. Superfici ricche di dettagli evocano una sensorialità autentica. Un equilibrio tra naturalezza e artigianalità, dove la matericità si fa protagonista.**

The material reveals itself to the touch, with intertwined textures that enhance the beauty of nature's creations. Surfaces rich in detail evoke an authentic sensory experience. A balance between naturalness and craftsmanship, where the materiality takes center stage.

## COLLECTIONS

---

Shabby

Bambù

Bouclé

Trame





# Collezione Shabby

Shabby  
collection

77

**SHABBY**  
Portavaso  
quadro  
PIL PV 75

67

**SHABBY**  
Portavaso  
TCRI PV 70

OG

**SHABBY**  
Sfera  
SFRI 40

GH

**SHABBY**  
Campana  
CMHA 45

67

**SHABBY**  
Cubo  
CUBRI 35

BW

**SHABBY**  
Campana  
CMHA 45

BW

**SHABBY**  
Tronco  
conico  
TBRI 30

67

**SHABBY**  
Portavaso  
TCRI PV 70

77

**SHABBY**  
Portavaso  
quadro  
PIL PV 75





BW

**SHABBY**  
Conchino  
CORI 45



BW

SHABBY  
Ciotola  
CTFS 35

67

SHABBY  
Sfera  
SFRI 40

SHABBY

Raccoglitore  
acqua piovana  
SHABBYRAIN 150



GH

**SHABBY**  
Vaso pensile  
VPBSH 25

77

67

GH

**SHABBY**  
Gerla a muro  
GERSY 30

Intrecci tattili





67

**SHABBY**  
Portavaso  
COSY PV 85

GH

**SHABBY**  
Cassetta alta  
CATLR 78

77

**SHABBY**  
Cassetta alta  
CASR PV 93

67

**SHABBY**  
Sfera  
SFRI 40

67

**SHABBY**  
Cassetta  
CATRI 78

GH

**SHABBY**  
Cassetta  
BASV 78







BW

**SHABBY**  
Vaso urbano  
ACASHAB 110







Intrecci tattili

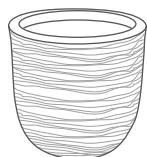

## Shabby

Conchino  
CORI









Codice Code				
<b>CORI 27</b>	27	26	12 Lt	NSTVC 20
<b>CORI 35</b>	35	34	25 Lt	NSTVC 28
<b>CORI 45</b>	45	43,5	55 Lt	NSTVC 34
<b>CORI 55</b>	56	60	123 Lt	NSTVC 38
<b>Colori Colors</b>				
<b>Specifiche tecniche</b> Technical specifications				

## Shabby

Campana  
CMHA





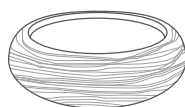

Codice Code				
<b>CMHA 45</b>	45	37	32Lt	NSTVC 28
<b>CMHA 55</b>	55	44,5	61 Lt	NSTVC 34
<b>Colori Colors</b>				
<b>Specifiche tecniche</b> Technical specifications				

## Shabby

Ciotola  
CTFS





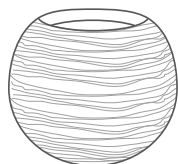

Codice Code			
<b>CTFS 35</b>	35	11	6,2 Lt
<b>CTFS 42</b>	42	12,5	13 Lt
<b>CTFS 50</b>	50	15	23 Lt
<b>Colori Colors</b>			
<b>Specifiche tecniche</b> Technical specifications			

## Shabby

Sfera  
SFRI

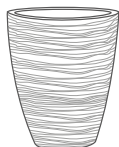

Codice Code			
<b>SFRI 30</b>	30	24	12,2 Lt
<b>SFRI 40</b>	40	33	30 Lt
<b>SFRI 50</b>	50	42	59 Lt
<b>Colori Colors</b>			
<b>Specifiche tecniche</b> Technical specifications			

**Shabby**Tronco conico  
**TBRI****Codice**  
Code**TBRI 30**

30

36

20 Lt

NSTVC 20

**TBRI 37**

37

44

35 Lt

NSTVC 24

**Colori**  
Colors

77

67

GH

BW

OG

**Specifiche tecniche**  
Technical specifications**Shabby**Portavaso  
**TCRI PV****Codice**  
Code**TCRI PV 70**

40

70

18 Lt

23

33

**Colori**  
Colors

77

67

GH

BW

OG

**Specifiche tecniche**  
Technical specifications**Shabby**Portavaso  
**COSY PV****Codice**  
Code**COSY PV 85**

38,5

85

28 Lt

26

26

**Colori**  
Colors

77

67

GH

BW

OG

**Specifiche tecniche**  
Technical specifications**Shabby**Portavaso quadro  
**PIL PV****Codice**  
Code**PIL PV 75**

32x32

75

18 Lt

24

28

**Colori**  
Colors

77

67

GH

BW

OG

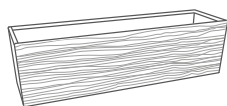
**Specifiche tecniche**  
Technical specifications**Shabby**Cassetta  
**BASY****Codice**  
Code**BASY 78**

78x22

22

32 Lt

**Colori**  
Colors

77

67

GH

BW

OG

**Specifiche tecniche**  
Technical specifications

## Shabby

Cassetta  
CATRI

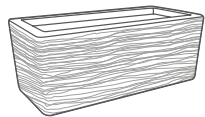

Codice  
Code



CATRI 78

79x35

30

66 Lt

Colori  
Colors

77

67

GH

BW

OG

Specifiche tecniche  
Technical specifications



## Shabby

Cassetta alta  
CATLR

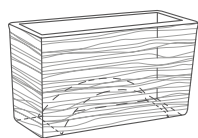

Codice  
Code



CATLR 78

78x35

61

115 Lt

Colori  
Colors

77

67

GH

BW

OG

Specifiche tecniche  
Technical specifications



## Shabby

Cassetta alta  
CASR PV

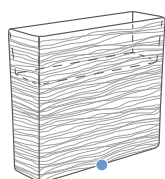

Codice  
Code



CASR PV 93

84x24

77

51 Lt

23

84x24

Colori  
Colors

77

67

GH

BW

OG

Specifiche tecniche  
Technical specifications



## Shabby

Cubo  
CUBRI

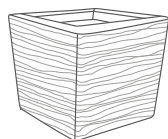

Codice  
Code



CUBRI 35

35x35

30

30 Lt

Colori  
Colors

77

67

GH

BW

OG

Specifiche tecniche  
Technical specifications



## Shabby

Vaso urbano  
ACASHAB



Codice  
Code



ACASHAB 110

106

71

510 Lt

Colori  
Colors

77

67

GH

BW

OG

Specifiche tecniche  
Technical specifications



## Shabby

Gerla a muro  
GERSY



Codice  
Code



GERSY 30\*

30X18

24

7 Lt

Colori  
Colors

77

67

GH

BW

OG

Specifiche tecniche  
Technical specifications

\*Con riserva d'acqua / With water reserve



## Shabby

Vaso pensile  
VPBSH



Codice  
Code



VPBSH 25

25

19

5,6

Colori  
Colors

77

67

GH

BW

OG

Specifiche tecniche  
Technical specifications



## Shabby

Raccoglitore acqua piovana  
RAIN



Codice  
Code



RAIN 150

46

106

155

7

28

RAIN 300

66

113

297

7

43

Colori  
Colors

67

GH

I

Specifiche tecniche  
Technical specifications



# Collezione Bambù

Bambù  
collection



FA

BAMBÙ  
Cassetta alta  
CANTL 78

OG

BAMBÙ  
Conchino  
CONCAN 40

FA 77

**BAMBÙ**  
Conchino  
CONCAN 40

FA

**BAMBÙ**  
Cassetta alta  
CANTL 78





## Bambù

Conchino  
**CONCAN**

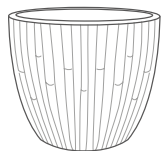

**Codice**  
Code

**CONCAN 40**



42



35



24 Lt

**Colori**  
Colors

77

FA

OG

**Specifiche tecniche**  
Technical specifications



## Bambù

Cassetta alta  
**CANTL**

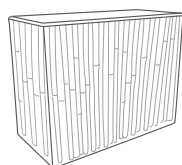

**Codice**  
Code

**CANTL 78**



81x37



63



168 Lt

**Colori**  
Colors

77

FA

OG

**Specifiche tecniche**  
Technical specifications





# Collezione Bouclé

Bouclé  
collection

46

BOUCLÉ  
Cilindro  
CILBOU 45



46

**BOUCLÉ**  
Cilindro  
CILBOU 45





**BOUCLÉ**  
Cilindro  
CILBOU 35



**BOUCLÉ**  
Cilindro  
CILBOU 40



**BOUCLÉ**  
Cilindro  
CILBOU 45



## Bouclé

Cilindro  
CILBOU

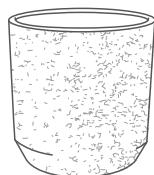

Codice  
Code

CILBOU 35

CILBOU 40

CILBOU 45

Colori  
Colors

Specifiche tecniche  
Technical specifications



35

37

26,5 Lt

40

46

43,5 Lt

46

46

57 Lt

77

I

46

DE

VV

56



## Bouclé

Cassetta  
CASBOU

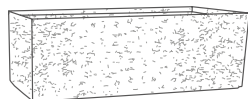

Codice  
Code

CASBOU 80

CASBOU 100 - COMING SOON

Colori  
Colors

Specifiche tecniche  
Technical specifications



83x40

40

95 Lt

100x34

40

129 Lt

77

I

46

DE

VV

56



## Bouclé

Cassetta alta  
CASHBOU

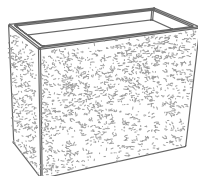

Codice  
Code

CASHBOU 78 - COMING SOON

Colori  
Colors

Specifiche tecniche  
Technical specifications



/

/

/

77

I

46

DE

VV

56



## Bouclé

Vaso urbano  
ACABOU

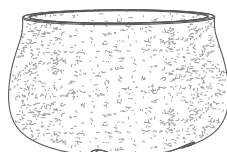

Codice  
Code

ACABOU 60- COMING SOON

Colori  
Colors

Specifiche tecniche  
Technical specifications



60

40

95 Lt

77

I

46

DE

VV

56







# Collezione Trame

Trame  
collection

67

TRAME  
Cilindro  
TICIL 35

DW

SACCO  
Cilindro  
SACCO 45

DW

**SACCO**  
Cilindro  
SACCO 45

67

**SACCO**  
Cilindro  
SACCO 45





**TRAME**  
Cilindro  
TICIL 35



## Sacco

Cilindro  
**SACCO**

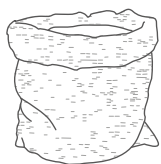

**Codice**  
Code



**SACCO 27**

27

22

8,3 Lt

**SACCO 45**

47

37

44 Lt

**SACCO 70**

70

50

107 Lt

**Colori**  
Colors



**Specifiche tecniche**  
Technical specifications



## Trame

Cilindro  
**TICIL**

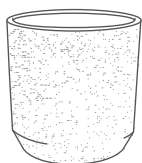

**Codice**  
Code



**TICIL 35**

36

40

29,5 Lt

**Colori**  
Colors



**Specifiche tecniche**  
Technical specifications





MOOD ABOUT  
COLLECTIONS

# Sussurri Marini

Sea waves whispers

Una brezza marina attraversa gli spazi, accarezzando superfici e portando con sé la calma dell'estate. Riflessi vibranti di un'estate lontana si intrecciano in forme morbide e tinte vivaci, evocando la freschezza della costa e il suo equilibrio naturale.

A sea breeze flows through the spaces, gently brushing over surfaces and bringing with it the calm of summer days. Vibrant reflections of a distant summer intertwine with soft shapes and vivid hues, evoking the freshness of the coast and its natural harmony.

COLLECTIONS

---

Bali





# Collezione Bali

Bali  
collection



67

BALI  
Portavaso  
BOMCORD PV 70

91

BALI  
Ciotola  
CIOCORD 40

46

BALI  
Conchino  
CONCORD 35

1

BALI  
Conchino  
CONCORD 20



**BALI**  
Vaso urbano  
ACACORD 78



91

**BALI**  
Conchino  
CONCORD 35

95

**BALI**  
Ciotola  
CIOCORD 40



67

BALI  
Portavaso  
BOMCORD PV 70

GD

BALI  
Sfera  
SFERCORD 40

77

BALI  
Cilindro  
CILCORD 60

67

BALI  
Cassetta  
CASCORD 80



**Bali**  
Conchino  
**CONCORD**

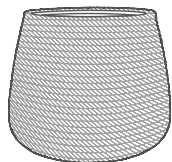

**Codice**  
Code



**CONCORD 20**

40

32

23 Lt

**CONCORD 35**

49

41

56 Lt

**Colori**  
Colors



**Specifiche tecniche**  
Technical specifications



**Giava**  
Cilindro  
**CILCORD**

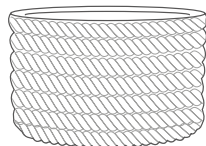

**Codice**  
Code



**CILCORD 60**

68

40

124 Lt

**CILCORD 80**

80

61

265 Lt

**Colori**  
Colors

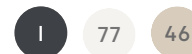

**Specifiche tecniche**  
Technical specifications



**Bali**  
Ciotola  
**CIOCORD**

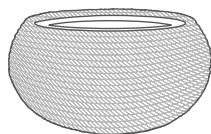

**Codice**  
Code



**CIOCORD 40**

40

21

14 Lt

**CIOCORD 50**

51

25

29 Lt

**Colori**  
Colors



**Specifiche tecniche**  
Technical specifications



**Bali**  
Sfera  
**SFERCORD**

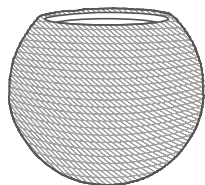

**Codice**  
Code



**SFERCORD 40**

40

34

23 Lt

**SFERCORD 50**

55

43

60 Lt

**Colori**  
Colors



**Specifiche tecniche**  
Technical specifications



## Bali

Portavaso  
**BOMCORD PV**

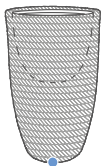

**Codice**  
Code



**BOMCORD PV 70**

41

70

18 Lt

23

33

**Colori**  
Colors



**Specifiche tecniche**  
Technical specifications



## Bali

Cassetta  
**CASCORD**

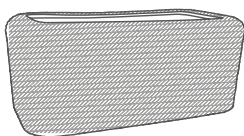

**Codice**  
Code



**CASCORD 80**

85x45

45

130 Lt

**Colori**  
Colors



**Specifiche tecniche**  
Technical specifications



## Bali

Vaso urbano  
**ACACORD**

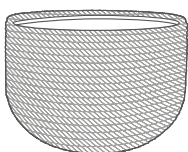

**Codice**  
Code



**ACACORD 78**

80

50

172 Lt

**Colori**  
Colors



**Specifiche tecniche**  
Technical specifications



MOOD ABOUT  
COLLECTIONS

# Tenui Atmosfere

Warm atmospheres

**Ombre soffuse che avvolgono lo spazio, forme sinuose che trasmettono equilibrio e calma. La morbidezza delle linee e i toni neutri creano atmosfere accoglienti, in cui ogni dettaglio evoca serenità. Una delicatezza che rende lo spazio leggero e armonioso.**

Soft shadows envelop the space, with flowing shapes that convey balance and calm. The softness of the lines and neutral tones create inviting atmospheres, where every detail evokes serenity. A delicacy that makes the space light and harmonious.

## COLLECTIONS

---

Gaudi

Bubble

Acaya





# Collezione Gaudi

Gaudi  
collection



97

GAUDI  
Cachepot  
VSGU 55

BI

GAUDI  
Cachepot  
VSGU 45

71

GAUDI  
Conchino  
CTGU 35

97

**GAUDI**  
Cassetta ovale  
CSGU 87

71

**GAUDI**  
Conchino  
CTGU 35

BI

**GAUDI**  
Cachepot  
VSGU 45

97

**GAUDI**  
Cachepot  
VSGU 55



## Gaudì

Conchino  
CTGU

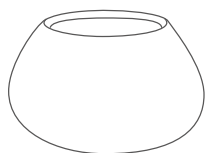

**Codice**  
Code



**CTGU 35**

64X61

37

75 Lt

**Colori**  
Colors

BI

71

97

**Specifiche tecniche**  
Technical specifications



## Gaudì

Cachepot  
VSGU 45



**Codice**  
Code



**VSGU 45**

67X62

45

103

**Colori**  
Colors

BI

71

97

**Specifiche tecniche**  
Technical specifications



## Gaudì

Cachepot  
VSGU 55



**Codice**  
Code



**VSGU 55**

64x59

55

106

**Colori**  
Colors

BI

71

97

**Specifiche tecniche**  
Technical specifications



## Gaudì

Cassetta ovale  
CSGU



**Codice**  
Code



**CSGU 87**

85X55

37

102

**Colori**  
Colors

BI

71

97

**Specifiche tecniche**  
Technical specifications





# Collezione Bubble

Bubble  
collection

S3

**BUBBLE**  
Conchino  
BCA 35

78

**BUBBLE**  
Portavaso  
BFU PV 75

BI

**BUBBLE**  
Conchino  
BCI 50



NE

**BUBBLE**  
Portavaso  
BFU PV 75

Tenui atmosfere



## Bubble

Conchino  
BCA



Codice  
Code

BCA 35

Colori  
Colors

Specifiche tecniche  
Technical specifications



49



40,5



56



## Bubble

Conchino  
BCI

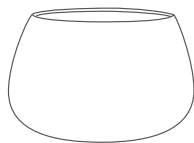

Codice  
Code

BCI 50

Colori  
Colors

Specifiche tecniche  
Technical specifications



67



38,5



111



## Bubble

Portavaso  
BFU PV

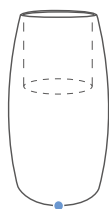

Codice  
Code

BFU PV 75

Colori  
Colors

Specifiche tecniche  
Technical specifications



45,5



75



18



20



30







# Collezione Acaya

Acaya  
collection



B3

ACAYA  
Vaso urbano  
ACAYA 84

77

78

BW

ACAYA  
Vaso urbano  
ACAYA 84

Tenji atmosfere



## Acaya

Vaso urbano  
ACAYA

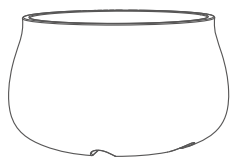

Codice  
Code

ACAYA 60

ACAYA 78

ACAYA 84

ACAYA 110

ACAYA 130

Colori  
Colors

Specifiche tecniche  
Technical specifications



60



40



95 Lt

78

50

172 Lt

84

56

280 Lt

110

70

510 Lt

130

90

1103 Lt

77

78

I

BW

B3





MOOD ABOUT  
COLLECTIONS

# Frammenti Urbani

Urban fragments

Spazi essenziali, sospesi tra materia e luce, impreziositi da dettagli e forme in grado di creare nuove frammentazioni dell'ambiente. Il pieno respira attraverso il vuoto, amplificando la presenza degli elementi. Geometrie pure emergono con forza, definendo un equilibrio tra solidità e leggerezza.

Essential spaces, suspended between matter and light, enriched by details and forms that create new fragmentations of the environment. The solid breathes through the void, amplifying the presence of the elements. Pure geometries emerge with strength, defining a balance between solidity and lightness.

## COLLECTIONS

---

Ardesia

City

Linea



# Collezione Ardesia

Ardesia  
collection

67

ARDESIA  
Cilindro  
CILAR 45

67

ARDESIA  
Cassetta  
CATLA 80

67

ARDESIA  
Cassetta alta  
CATLH 75

QZ

**ARDESIA**  
Cubo  
CUBLA 30

PH

**ARDESIA**  
Portavaso quadro  
CUBLA PV 75

55

**ARDESIA**  
Cubo  
CUBLA B 15

B3

**ARDESIA**  
Cassetta alta  
CATLH 75







55

**ARDESIA**  
Portavaso  
CILAR PV 75

B3

**ARDESIA**  
Cilindro  
CILAR 35

PH

ARDESIA  
Portavaso quadro  
CUBLA PV 75

B3

ARDESIA  
Cassetta alta  
CATLH 75



## Ardesia

Cilindro  
**CILAR**



**Codice**  
Code



**CILAR 25**

26

30

10 Lt

NSTVC 20

**CILAR 35**

36

41

28 Lt

NSTVC 32

**CILAR 45**

46

46

55 Lt

NSTVC 40

**Colori**  
Colors

67

55

PH

QZ

B3

**Specifiche tecniche**  
Technical specifications



## Ardesia

Portavaso  
**CILAR PV**



**Codice**  
Code



**CILAR PV 75**

33

75

14 Lt

22

28,5

**Colori**  
Colors

67

55

PH

QZ

B3

**Specifiche tecniche**  
Technical specifications



## Ardesia

Portavaso quadro  
**CUBLA PV**

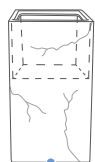

**Codice**  
Code



**CUBLA PV 75**

30x30

75

12 Lt

21

26

**Colori**  
Colors

67

55

PH

QZ

B3

**Specifiche tecniche**  
Technical specifications



## Ardesia

Cassetta  
**CATLA**

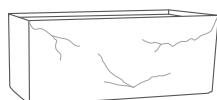

**Codice**  
Code



**CATLA 80**

81x41

40

112 Lt

**CATLA 100**

102X41

40

135 Lt

**Colori**  
Colors

67

55

PH

QZ

B3

**Specifiche tecniche**  
Technical specifications



## Ardesia

Cassetta alta  
CATLH

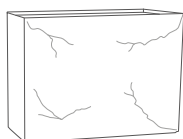

**Codice**  
Code



**CATLH 75**

80x30

75

171 Lt

**Colori**  
Colors

67

55

PH

QZ

B3

**Specifiche tecniche**  
Technical specifications



## Ardesia

Cubo  
CUBLA



**Codice**  
Code



**CUBLA 30**

30x30

40

31 Lt

**CUBLA 40**

40x40

40

52 Lt

**Colori**  
Colors

67

55

PH

QZ

B3

**Specifiche tecniche**  
Technical specifications



## Ardesia

Cubo  
CUBLA B

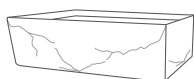

**Codice**  
Code



**CUBLA B 15**

40,5x40,5

15

17 Lt

**Colori**  
Colors

67

55

PH

QZ

B3

**Specifiche tecniche**  
Technical specifications



# Collezione City

City  
collection

55

CITY  
Portavaso quadro  
CURG PV 75

46

CITY  
Cilindro  
CLRG 45

46

**CITY**  
Portavaso  
CLRG PV 70

46

**CITY**  
Cilindro  
CLRG 45





55

**CITY**  
Cubo  
CURG 40

55

**CITY**  
Cassetta  
CSRG 90

55









**CITY**  
Cassetta alta  
CSRGH 75











55











**CITY**  
Portavaso quadro  
CURG PV 75





<b>City</b> Cilindro <b>CLRG</b> 	<b>Codice</b> Code			
	<b>CLRG 27</b>	27,5	30	15 Lt
	<b>CLRG 35</b>	36	35	31 Lt
	<b>CLRG 45</b>	46	45	66 LT
	<b>Colori</b> Colors			  
<b>Specifiche tecniche</b> Technical specifications				

<b>City</b> Portavaso <b>CLRG PV</b> 	<b>Codice</b> Code					
	<b>CLRG PV 70</b>	33	69	14 Lt	22	29
	<b>Colori</b> Colors				  	
	<b>Specifiche tecniche</b> Technical specifications					

<b>City</b> Portavaso quadro <b>CURG PV</b> 	<b>Codice</b> Code					
	<b>CURG PV 75</b>	33x33	75	18 Lt	22	29
	<b>Colori</b> Colors				  	
	<b>Specifiche tecniche</b> Technical specifications					

<b>City</b> Cassetta <b>CSRG</b> 	<b>Codice</b> Code			
	<b>CSRG 90</b>	92x41	33,5	105 Lt
	<b>Colori</b> Colors			  
	<b>Specifiche tecniche</b> Technical specifications			

## City

Cassetta alta  
CSRGH

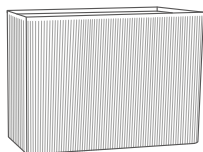

**Codice**  
Code



**CSRGH 75**

80x33

75

181 Lt

**Colori**  
Colors

55

77

46

**Specifiche tecniche**  
Technical specifications



## City

Cubo  
CURG

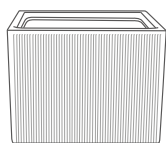

**Codice**  
Code



**CURG 30**

30x30

40

36 Lt

**CURG 40**

41x41

33,5

50 Lt

**Colori**  
Colors

55

77

46

**Specifiche tecniche**  
Technical specifications



# Collezione Linea

Linea  
collection



**LINEA**  
Cassetta alta  
CASLINEA PV 90



**LINEA**  
Cassetta  
CASLINEA 80



**LINEA**  
Cassetta  
CASLINEA 80



**LINEA**  
Cassetta alta  
CASLINEA PV 90



## Linea

Cassetta  
CASLINEA

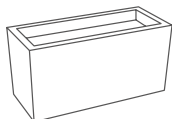

**Codice**  
Code



**CASLINEA 80**

80x34

39

84 Lt

**CASLINEA 100**

100x34

39

112 Lt

**Colori**  
Colors



**Specifiche tecniche**  
Technical specifications



## Linea

Cassetta alta  
CASLINEA PV

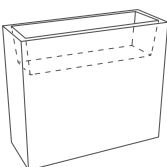

**Codice**  
Code



**CASLINEA PV - COMING SOON**

/

/

/

**Colori**  
Colors



**Specifiche tecniche**  
Technical specifications



MOOD ABOUT  
COLLECTIONS

# Pura Essenza

Purest essence



**L'essenziale si manifesta in gesti semplici, in forme che appartengono al quotidiano. Spazi familiari che celebrano la semplicità, dove l'umiltà dei dettagli rivela un'eleganza discreta. Un equilibrio naturale che parla di autenticità e bellezza sincera.**

The essential is revealed in simple gestures, in shapes that belong to everyday life. Familiar spaces that celebrate simplicity, where the humility of details unveils a discreet elegance. A natural balance that speaks of authenticity and genuine beauty.

## COLLECTIONS

---

Quadra

Tonda

Leviga

Crespia





# Collezione Quadra

Quadra  
collection



55

**MATELICA**  
Cassetta alta  
CATL 78

I

**MATELICA**  
Cassetta  
CATL B 78

B3

**VIAREGGIO**  
Cubo  
CUBL 40

55

**MONTIERI**  
Portavaso  
quadro  
LTR PV 85



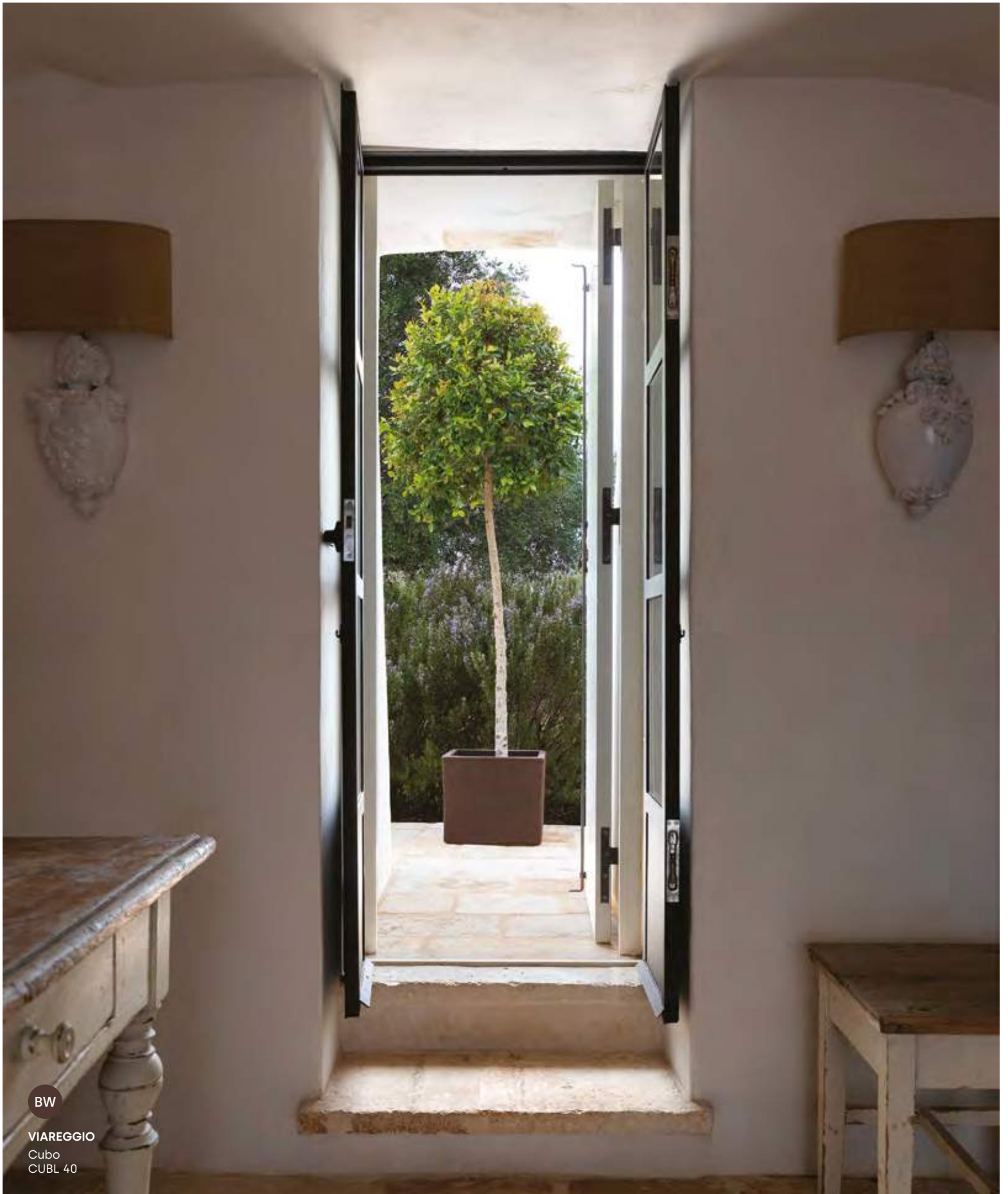

BW

VIAREGGIO

Cubo  
CUBL 40

1

**SENIGALIA**  
Cassetta  
BATL 50

78

**MATELICA**  
Cassetta  
CATL XL 100





**LAGO LESINA**  
Tronco conico  
PRICO 40



78

**CECINA**  
Portavaso quadro  
QNS PV 85





78

**IVREA**  
Cassetta alta  
VNS PV 61

78

**VOGHERA**  
Cassetta alta  
CSTS PV 93





## Lago lesina

Tronco conico  
PRICO

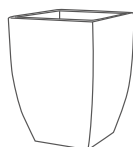

Codice Code					
PRICO 40	30x30	40	28 Lt	/	SVQR 21
PRICO 50	38x38	50	55 Lt	STVQ 30	/
PRICO 60	46x46	60	97 Lt	STVQ 37	/
Colori Colors					77 78 I
Specifiche tecniche Technical specifications					

## Montieri

Portavaso quadro  
LTR PV

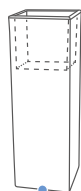

Codice Code					
LTR PV 85	28x28	85	17 Lt	23	25
Colori Colors					55 77 78 I NE
Specifiche tecniche Technical specifications					

## Cecina

Portavaso quadro  
QNS PV

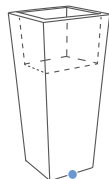

Codice Code					
QNS PV 85	38x38	85	30 Lt	26	32
QNS PV 95	42x42	95	35 Lt	26	36
Colori Colors					77 78 I
Specifiche tecniche Technical specifications					

## Matelica

Cassetta  
CATL XL 100

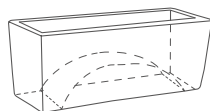

Codice Code					
CATL XL 100	100x40	40	150 Lt	STVR 95	
Colori Colors					77 78 I 55 B3 BW
Specifiche tecniche Technical specifications					

## Matelica

Cassetta  
CATL B



Codice Code				
<b>CATL B 78</b>	78x35	31	68 Lt	STVR 78
<b>CATL B 100</b>	100x35	31	88 LT	SVR 9934
<b>Colori</b> Colors				
<b>Specifiche tecniche</b> Technical specifications				

## Senigallia

Cassetta  
BATL



Codice Code				
<b>BATL 50</b>	50x22	22	21 Lt	
<b>BATL 78</b>	78x22	22	32 Lt	
<b>Colori</b> Colors				
<b>Specifiche tecniche</b> Technical specifications				

## Matelica

Cassetta alta  
CATL

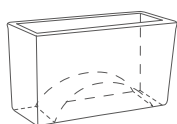

Codice Code				
<b>CATL 75</b>	75x30	42	73 Lt	/
<b>CATL 78</b>	78x35	61	115 Lt	STVR 78
<b>CATL 100</b>	100x35	61	160 Lt	SVR 9533
<b>Colori</b> Colors				
<b>Specifiche tecniche</b> Technical specifications				

## Voghera

Cassetta alta  
CSTS PV

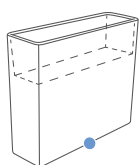

Codice Code					
<b>CSTS PV 93</b>	90x29	77	33 Lt	19	83x22
<b>Colori</b> Colors					
<b>Specifiche tecniche</b> Technical specifications					

## Ivrea

Cassetta alta  
VNS PV

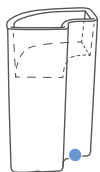

**Codice**  
Code



**VNS PV 61**

61x28

77

25 Lt

19

53x21

**Colori**  
Colors



**Specifiche tecniche**  
Technical specifications



## Viareggio

Cubo  
CUBL

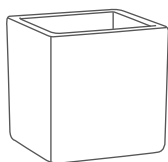

**Codice**  
Code



**CUBL 30**

30x30

30

18 Lt

**CUBL 35**

35x35

33

27 Lt

**CUBL 40**

40x40

35

42 Lt

**CUBL 50**

50x50

48

84 Lt

**CUBL 60**

60x60

56

180 Lt

**Colori**  
Colors



**Specifiche tecniche**  
Technical specifications





# Collezione Tonda

Tonda  
collection

1

**TORTONA**  
Portavaso  
CNS PV 95

78

**GRAGNANO**  
Tronco conico  
COMP 50

78

**GRAGNANO**  
Tronco conico  
COMP 70



77

**TARVISIO**  
Vaso angolare  
VALMO 55

77

**TOLMEZZO**  
Vaso a parete  
VALPO 60







78

**GIOVINAZZO**  
Campana  
CMFB 55

78

**POLIGNANO**  
Campana  
CMFS 75



## Polignano

Campana  
CMFS

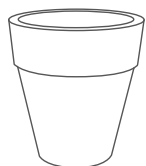

Codice  
Code



**CMFS 65**

65

70

121 Lt

NSTVC 36

**CMFS 75**

70

75

140 Lt

NSTVC 40

**CMFS 85**

84

90

256 Lt

NSTVC 46

**Colori**

Colors

77

78

I

**Specifiche tecniche**

Technical specifications



## Giovinazzo

Campana  
CMFB

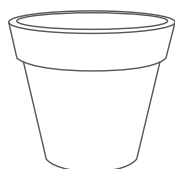

Codice  
Code



**CMFB 35**

35

32

15 Lt

NSTVC 20

**CMFB 45**

45

40

30 Lt

NSTVC 26

**CMFB 55**

55

49

58 Lt

NSTVC 32

**Colori**

Colors

77

78

I

**Specifiche tecniche**

Technical specifications



## Vulcano

Cachepot  
VSLC



Codice  
Code



**VSLC 30**

60

35

53 Lt

**VSLC 50**

60

50

84 Lt

**VSLC 70**

60

70

120 Lt

**Colori**

Colors

77

78

I

**Specifiche tecniche**

Technical specifications



## Gragnano

Tronco conico  
COMP

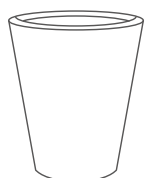

Codice  
Code



**COMP 50**

50

60

39 Lt

NSTVC 36

**COMP 60**

60

73

67 Lt

NSTVC 42

**COMP 70**

70

84

95 Lt

NSTVC 48

**Colori**

Colors

77

78

BW

**Specifiche tecniche**

Technical specifications



## Tortona

Portavaso  
CNS PV



Codice Code								
<b>CNS PV 70</b>	31	71	14 Lt	23	28			
<b>CNS PV 85</b>	38,5	85	28 Lt	26	35			
<b>CNS PV 95</b>	42	95	25 Lt	26	38			
<b>Colori</b> Colors								
<b>Specifiche tecniche</b> Technical specifications								

## Tolmezzo

Vaso a parete  
VALPO



Codice Code				
<b>VALPO 60</b>	57x33	61	80 Lt	
<b>Colori</b> Colors				
<b>Specifiche tecniche</b> Technical specifications				

## Tarvisio

Vaso angolare  
VALMO



Codice Code				
<b>VALMO 55</b>	74x45	61	100 Lt	
<b>Colori</b> Colors				
<b>Specifiche tecniche</b> Technical specifications				

# Collezione Leviga

Leviga  
collection



78

**SAVONA**  
Conchino  
CLSB 40

78

**CAMAIORE**  
Ciotola  
CSLT 45

78

**CAMAIORE**  
Ciotola  
CSLT 35

78

**PORTO BADISCO**  
Tronco conico  
TROCO 60





55

GUBBIO  
Conchino  
CSL 35



## Savona

Conchino  
CLSB



Codice  
Code



CLSB 30

30

25

10 Lt

NSTVC 20

CLSB 40

40

33

23 Lt

NSTVC 28

CLSB 50

50

42

50 Lt

NSTVC 36

CLSB 60

60

50

95 Lt

NSTVC 42

Colori  
Colors

77

78

1

Specifiche tecniche  
Technical specifications



## Gubbio

Conchino  
CSL



Codice  
Code



CSL 30

30

29

15 Lt

NSTVC 24

CSL 35

35

34

24 Lt

NSTVC 26

CSL 45

45

41

50 Lt

NSTVC 34

Colori  
Colors

55

77

78

1

Specifiche tecniche  
Technical specifications



## Camaiore

Ciotola  
CSLT



Codice  
Code



CSLT 35

37

17

11 Lt

NSTVC 26

CSLT 45

47

22

21 Lt

NSTVC 30

CSLT 55

58

28

42 Lt

NSTVC 36

Colori  
Colors

55

77

78

1

Specifiche tecniche  
Technical specifications



## Porto badisco

Tronco conico  
TROCO

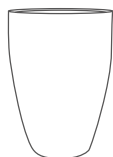

Codice  
Code



TROCO 40

30

40

22 Lt

NSTVC 20

TROCO 50

38

50

43 Lt

NSTVC 26

TROCO 60

46

60

78 Lt

NSTVC 30

Colori  
Colors

77

78

1

Specifiche tecniche  
Technical specifications



# Monastir

Orcio  
VCSD



**Codice**  
Code



**VCSD 44**

44

50

46 Lt

**Colori**  
Colors

77

78

**Specifiche tecniche**  
Technical specifications





# Collezione Crespia

Crespia  
collection

78

## CASTRO

Tronco conico  
TROBB 36

77

## MURGE

Cassetta ovale  
COVGL 40

78

## CASCINA

Cachepot  
CSPBO 36







77

**LAGHI ALMINI**  
Tronco conico  
PRIBO 45

77

**LAGHI ALMINI**  
Tronco conico  
PRIBO 55



## Cascina

Cachepot  
CSPBO

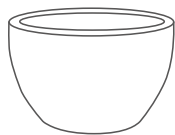

Codice  
Code



CSPBO 36

36

23

8 Lt

NSTVC 24

CSPBO 50

50

23

16 Lt

NSTVC 38

Colori  
Colors

77

78

99

Specifiche tecniche  
Technical specifications



## Castro

Tronco conico  
TROBB

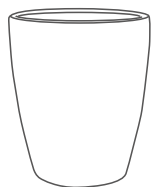

Codice  
Code



TROBB 28

24

28

6 Lt

NSTVC 16

TROBB 36

30

36

15 Lt

NSTVC 20

TROBB 44

37

44

27 Lt

NSTVC 24

Colori  
Colors

77

78

1

Specifiche tecniche  
Technical specifications



## Laghi alimini

Tronco conico  
PRIBO

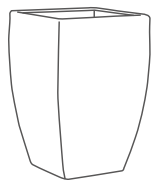

Codice  
Code



PRIBO 35

23x23

35

12 Lt

SVQR 16

PRIBO 45

30x30

45

27 Lt

SVQR 21

PRIBO 55

36x36

55

50 Lt

SVQR 25

Colori  
Colors

77

1

Specifiche tecniche  
Technical specifications



## Murge

Cassetta ovale  
COVGL



Codice  
Code



COVGL 40

40x25

17

9 Lt

COVGL 46

46x28

19

12 Lt

Colori  
Colors

77

1

Specifiche tecniche  
Technical specifications



# Stelvio

Vaso pensile  
VPCL



**Codice**  
Code

**VPCL 25**

**Colori**  
Colors

**Specifiche tecniche**  
Technical specifications



25



35



3 Lt

77

78

99

**Con catenella**  
With chain

MOOD ABOUT  
COLLECTIONS

# Radici Mediterranee

Mediterranean Roots

**Profumi di terra e mare, tradizioni che affiorano tra antichi colori e linee senza tempo. Spazi che raccontano il calore mediterraneo, fatti di tonalità e dettagli che richiamano una cultura autentica. Un ritorno alle origini, dove ogni elemento celebra l'eterna bellezza del passato.**

Scents of earth and sea, traditions emerging through ancient colors and timeless lines. Spaces that embody Mediterranean warmth, crafted with tones and details that reflect an authentic culture. A return to origins, where every element celebrates the eternal beauty of the past.

## COLLECTIONS

---

Lombardia

Country

Impero





# Collezione Lombardia

Lombardia  
collection



99

**LOMBARDIA**  
Vaso a parete  
PMI 40/4

99

**LOMBARDIA**  
Cubo  
QUM 35

99

**LOMBARDIA**  
Cassetta  
CRI 80

99

**LOMBARDIA**  
Cubo  
QUM 35

99

**LOMBARDIA**  
Vaso a parete  
PMI 40/4

99

**LOMBARDIA**  
Cassetta  
CRI 80



## Lombardia

Cassetta  
CRI

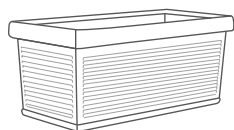

Codice Code					
<b>CRI 50</b>	50x26	24	17 Lt	/	SVRR 45/L
<b>CRI 60</b>	63x33	29	33 Lt	STVR 59	/
<b>CRI 70</b>	73x35	31	44 Lt	SVR 6931	SVRR 67/B
<b>CRI 80/3</b>	83x38	34	43 Lt	STVR 78	SVRR 77
<b>CRI 100/3</b>	100x38	34	53 Lt	SVR 9533	/
<b>CRI 90</b>	93x42	37	91 Lt	STVR 88	SVRR 87
<b>CRI 101/4</b>	103x47	40	89 Lt	STVR 108	SVRR 95/4
<b>CRI 120/4</b>	120x47	40	100 Lt	/	SVRR 113

Colori  
Colors

99

Specifiche tecniche  
Technical specifications



## Lombardia

Cubo  
QUM

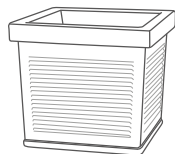

Codice Code					
<b>QUM 30</b>	32x32	27	14 Lt	STVQ 30	/
<b>QUM 35/3</b>	37x37	34	27 Lt	STVQ 37	/
<b>QUM 40</b>	42x42	37	38 Lt	STVQ 42	SVQR 39
<b>QUM 45/4</b>	47x47	40	56 Lt	STVQ 51	SVQR 42
<b>QUM 50</b>	50x50	50	77 Lt	STVQ 51	/
<b>QUM 60</b>	62x62	40	82 Lt	STVQ 69	/

Colori  
Colors

99

Specifiche tecniche  
Technical specifications



## Lombardia

Vaso a parete  
PMI



Codice Code				
<b>PMI 40/4</b>	47x32	40	27 Lt	STVD 42

Colori  
Colors

99

Specifiche tecniche  
Technical specifications





# Collezione Country

Country  
collection

78

**RAGUSA**  
Campana  
CMRO 40

77

**LECCE**  
Ciotola  
CTLEC 40

77

**LECCE**  
Ciotola  
CTLEC 40

78

**RAGUSA**  
Campana  
CMRO 40

77

**RAGUSA**  
Cassetta ovale  
CASTOR 46



## Ragusa

Campana  
CMRO

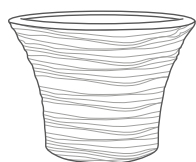

**Codice**  
Code



**CMRO 40**

40

30

13 Lt

NSTVC 24

**CMRO 50**

50

38

28 Lt

NSTVC 32

**Colori**  
Colors

77

78

**Specifiche tecniche**  
Technical specifications



## Lecce

Ciotola  
CTLEC

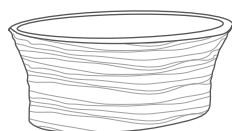

**Codice**  
Code



**CTLEC 40**

40

17

9 Lt

NSTVC 32

**Colori**  
Colors

77

**Specifiche tecniche**  
Technical specifications



## Ragusa

Cassetta ovale  
CASTOR

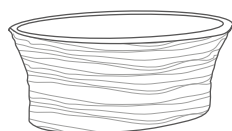

**Codice**  
Code



**CASTOR 46**

46x26

19

7 Lt

SVOR 40

**Colori**  
Colors

77

78

**Specifiche tecniche**  
Technical specifications



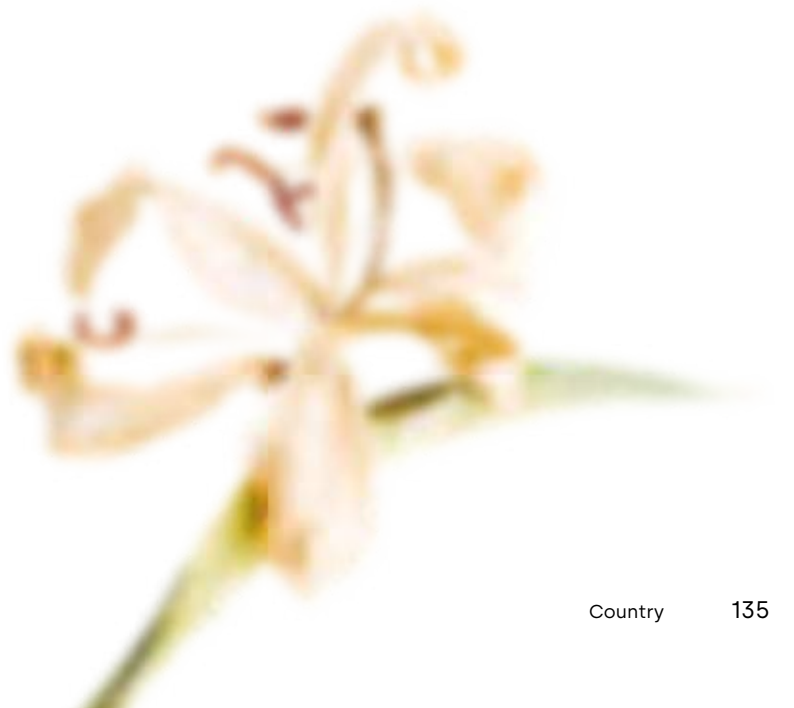



# Collezione Impero

Impero  
collection



99

EGNAZIA  
Calice  
CALEG 40

99

TROPEA  
Campana  
CNFA 40



**ROMA**  
Calice  
CAFE 49



99

**SALERNO**  
Gerla a muro  
PFSA 21

99

**FRIULI**  
Vaso a parete  
PFRI 40



99

**LAZIO**  
Cassetta  
CFE 80

99

**LAGO DI COMO**  
Cubo  
QUCO 50

99

**TROPEA**  
Campana  
CNFA 78

## Tropea

Campana  
CNFA



Codice Code				
<b>CNFA 25</b>	25	20	3 Lt	NSTVC 16
<b>CNFA 30</b>	30	25	5 Lt	NSTVC 18
<b>CNFA 35</b>	35	29	9 Lt	NSTVC 20
<b>CNFA 40</b>	40	34	15 Lt	NSTVC 22
<b>CNFA 45</b>	44	37	25 Lt	NSTVC 26
<b>CNFA 50</b>	50	41	28 Lt	NSTVC 28
<b>CNFA 56</b>	53	45	36 Lt	NSTVC 32
<b>CNFA 67</b>	66	52	61 Lt	NSTVC 38
<b>CNFA 72</b>	71	56	77 Lt	NSTVC 40
<b>CNFA 78</b>	77	62	102 Lt	NSTVC 44
<b>CNFA 95</b>	95	77	215 Lt	NSTVC 54

**Colori**  
Colors

99

**Specifiche tecniche**  
Technical specifications



## Egnazia

Calice  
CALEG



Codice Code				
<b>CALEG 40</b>	40	46	23 Lt	SVQR 25

**Colori**  
Colors

99

**Specifiche tecniche**  
Technical specifications



## Roma

Calice  
CAFE



Codice Code			
<b>CAFE 40</b>	40	47	14 Lt
<b>CAFE 49</b>	49	57	25 Lt

**Colori**  
Colors

BI

**Specifiche tecniche**  
Technical specifications



## Lazio

Cassetta  
CRI



Codice Code					
<b>CFE 50</b>	50x23	20	11 Lt	/	SVRR 48
<b>CFE 60</b>	60x28	24	21 Lt	STVR 57	SVRR 58
<b>CFE 80</b>	80x36	33	42 Lt	STVR 75	SVRR 75
<b>CFE 100</b>	100x45	40	83 Lt	STVR 95	SVRR 92

**Colori**  
Colors

99

**Specifiche tecniche**  
Technical specifications



## Lago di como

Cubo  
QUCO



Codice Code					
<b>QUCO 40</b>	40x40	34	25 Lt	STVQ 37	/
<b>QUCO 50</b>	49x49	41	47 Lt	STVQ 42	SVQR 39

**Colori**  
Colors

99

**Specifiche tecniche**  
Technical specifications



## Friuli

Vaso a parete  
PFRI



Codice Code				
<b>PFRI 40</b>		41x25	40	19 Lt
<b>PFRI 53</b>		54x33	53	45 Lt

**Colori**  
Colors

99

**Specifiche tecniche**  
Technical specifications



## Salerno

Gerla a muro  
PFSA



Codice Code			
<b>PFSA 21</b>			31x18
		21	
			3 Lt

**Colori**  
Colors

99

**Specifiche tecniche**  
Technical specifications



MOOD ABOUT  
COLLECTIONS

# Sfumature classiche

Classical nuances

Forme classiche si trasformano, trovando freschezza in contesti vibranti. Elementi e linee essenziali evocano una raffinatezza senza tempo, arricchita da tonalità e contrasti che rinnovano la tradizione. Una rilettura contemporanea che dà vita ad eleganti equilibri tra passato e presente.

Classic forms are reimagined, finding freshness in vibrant settings. Essential elements and lines evoke a timeless sophistication, enriched by tones and contrasts that renew tradition. A contemporary reinterpretation that brings to life elegant balances between past and present.

## COLLECTIONS

---

Agrigento

Classico impruneta

Nastro





# Collezione Agrigento

Agrigento  
collection



F1

**AGRIGENTO**  
Cilindro  
CIPO 50

F1

**AGRIGENTO**  
Cilindro  
CIPOH 55

F1

**AGRIGENTO**  
Ciotola  
CTPO 56

F1

**AGRIGENTO**  
Cassetta  
CAPOR 80

F1

**AGRIGENTO**  
Cubo  
QUPO 35



## Agrigento

Cilindro  
CIPO



Codice  
Code



CIPO 50

50

37

46 Lt

NSTVC 42

Colori  
Colors

F1

Specifiche tecniche  
Technical specifications



## Agrigento

Cilindro  
CIPOH



Codice  
Code



CIPOH 55

50

55

76 Lt

NSTVC 42

Colori  
Colors

F1

Specifiche tecniche  
Technical specifications



## Agrigento

Ciotola  
CTPO

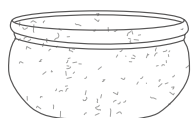

Codice  
Code



CTPO 56

56

28

44 Lt

NSTVC 42

Colori  
Colors

F1

Specifiche tecniche  
Technical specifications



## Agrigento

Cassetta  
CAPOR

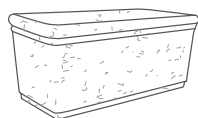

Codice  
Code



CAPOR 80

80x35

33

56 Lt

CAPOR 100

100x43

40

110 Lt

Colori  
Colors

F1

Specifiche tecniche  
Technical specifications



## Agrigento

Cubo  
QUPO



Codice  
Code



QUPO 35

35x35

33

24 Lt

QUPO 45

45x45

41

52 Lt

Colori  
Colors

F1

Specifiche tecniche  
Technical specifications





# Collezione Classico impruneta

Classico  
impruneta  
collection



99

PERUGIA  
Cachepot  
CSPCI 55

99

PERUGIA  
Cachepot  
CSPCI 35

99

PANAREA  
Ciotola  
CTLP 35

99

**SORRENTO**  
Cilindro  
CISO 50

99

**JESOLO**  
Campana  
CMDB 60



## Sorrento

Cilindro  
CISO



Codice Code				
<b>CISO 30</b>	30	23	7 Lt	NSTVC 22
<b>CISO 35</b>	35	27	11 Lt	NSTVC 26
<b>CISO 40</b>	40	30	17 Lt	NSTVC 30
<b>CISO 45</b>	45	34	25 Lt	NSTVC 34
<b>CISO 50</b>	50	38	36 Lt	NSTVC 38
<b>CISO 60</b>	60	45	60 Lt	NSTVC 46
<b>CISO 70</b>	70	52	100 Lt	NSTVC 52

Colori  
Colors

99

Specifiche tecniche  
Technical specifications



## Jesolo

Campana  
CMDB

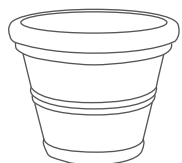

Codice Code				
<b>CMDB 20</b>	20	17	2 Lt	/
<b>CMDB 25</b>	25	21	3 Lt	NSTVC 16
<b>CMDB 30</b>	30	24	5 Lt	NSTVC 18
<b>CMDB 35</b>	35	28	10 Lt	NSTVC 22
<b>CMDB 40</b>	40	33	14 Lt	NSTVC 24
<b>CMDB 45</b>	45	37	23 Lt	NSTVC 28
<b>CMDB 50</b>	50	41	30 Lt	NSTVC 30
<b>CMDB 55</b>	55	45	42 Lt	NSTVC 34
<b>CMDB 60</b>	60	49	54 Lt	NSTVC 36
<b>CMDB 70</b>	70	56	82 Lt	NSTVC 42
<b>CMDB 80</b>	80	65	140 Lt	NSTVC 48
<b>CMDB 95</b>	95	77	233 Lt	NSTVC 58
<b>CMDB 110</b>	110	86	336 Lt	/
<b>CMDB 135</b>	135	90	505 Lt	/
<b>CMDB 155</b>	155	102	805 Lt	/

Colori  
Colors

99

Specifiche tecniche  
Technical specifications



## Panarea

Ciotola  
CTLP



Codice Code				
<b>CTLP 35</b>	35	14	5 Lt	NSTVC 22
<b>CTLP 45</b>	45	18	8 Lt	NSTVC 26
<b>CTLP 55</b>	55	22	17 Lt	NSTVC 32
<b>CTLP 65</b>	65	24	23 Lt	NSTVC 38
<b>CTLP 75</b>	75	29	32 Lt	NSTVC 44
<b>CTLP 85</b>	85	31	74 Lt	NSTVC 48
<b>Colori</b> Colors				77 99
<b>Specifiche tecniche</b> Technical specifications				

## Perugia

Cachepot  
CSPCI

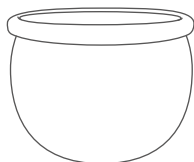

Codice Code				
<b>CSPCI 35</b>	35	27	18 Lt	NSTVC 24
<b>CSPCI 45</b>	45	34	38 Lt	NSTVC 30
<b>CSPCI 55</b>	55	42	67 Lt	NSTVC 36
<b>Colori</b> Colors				77 99
<b>Specifiche tecniche</b> Technical specifications				



# Collezione Nastro

Nastro  
collection



99

PORTO ROSA  
Campada  
CMFL 45

77

**CHIETI**  
Tronco conico  
COFA 50

I

**CHIETI**  
Tronco conico  
COFA 30





**CHIETI**  
Tronco conico  
COFA 30

77

**CHIETI**  
Tronco conico  
COFA 40

77

**PORTO ROSA**  
Campada  
CMFL 35



## Porto rosa

Campada  
CMFL



Codice Code				
<b>CMFL 25</b>	25	23	4 Lt	/
<b>CMFL 35</b>	35	30	12 Lt	NSTVC 18
<b>CMFL 40</b>	40	34	17 Lt	NSTVC 22
<b>CMFL 45</b>	45	38	21 Lt	NSTVC 24
<b>CMFL 55</b>	55	45	38 Lt	NSTVC 30
<b>Colori</b> Colors				
<b>Specifiche tecniche</b> Technical specifications				

## Chieti

Tronco conico  
COFA

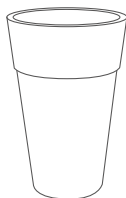

Codice Code				
<b>COFA 30</b>	30	46	15 Lt	NSTVC 18
<b>COFA 40</b>	40	62	37 Lt	NSTVC 24
<b>COFA 50</b>	50	77	79 Lt	NSTVC 30
<b>Colori</b> Colors				
<b>Specifiche tecniche</b> Technical specifications				



---

**Conchino** | Round pot



CONCORD  
**Bali**  
p. 58



CLSB  
**Leviga**  
p. 114



CSL  
**Leviga**  
p. 117



CORI  
**Shabby**  
p. 26



BCA  
**Bubble**  
p. 68



BCI  
**Bubble**  
p. 68



CTGU  
**Gaudi**  
p. 64



CONCAN  
**Bambù**  
p. 38

---

**Cilindro** | Cylinder



CILBOU  
**Bouclé**  
p. 42



SACCO  
**Trame**  
p. 48



TICIL  
**Trame**  
p. 48

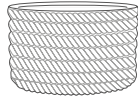

CILCORD  
**Bali**  
p. 59



CILAR  
**Ardesia**  
p. 78



CLRG  
**City**  
p. 84



CIPO  
**Agrigento**  
p. 145



CIPOH  
**Agrigento**  
p. 145



CISO  
**Classico impruneta**  
p. 149

---

**Campana** | Bell-shaped pot



CMHA  
**Shabby**  
p. 24



CMFS  
**Tonda**  
p. 111



CMFB  
**Tonda**  
p. 111



CMRO  
**Country**  
p. 132



CNFA  
**Impero**  
p. 136



CMDB  
**Classico impruneta**  
p. 149



CMFL  
**Nastro**  
p. 152

---

**Ciotola** | Bowl



CTPO  
**Agrigento**  
p. 145



CTLP  
**Classico impruneta**  
p. 148



CIOCORD  
**Bali**  
p. 56



CTFS  
**Shabby**  
p. 27



CSLT  
**Leviga**  
p. 114



CTLEC  
**Country**  
p. 132

---

**Sfera** | Sphere



SFERCORD  
**Bali**  
p. 59

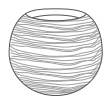

SFRI  
**Shabby**  
p. 24

---

**Calice** | Goblet



CALEG  
**Impero**  
p. 136



CAFE  
**Impero**  
p. 137

## Cachepot | Cachepot



VSGU 45  
**Gaudi**  
p. 64



VSGU 55  
**Gaudi**  
p. 64



VSLC  
**Tonda**  
p. 110



CSPBO  
**Crespia**  
p. 120



CSPCI  
**Classico impruneta**  
p. 148

## Tronco conico | Truncated cone



COMP  
**Tonda**  
p. 108



COFA  
**Nastro**  
p. 153



TBRI  
**Shabby**  
p. 25



TROBB  
**Crespia**  
p. 120



TROCO  
**Leviga**  
p. 114



PRIBO  
**Crespia**  
p. 123



PRICO  
**Quadra**  
p. 100

## Portvaso | Tall pot with insert

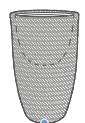

BOMCORD  
**Bali**  
p. 56



COSY PV  
**Shabby**  
p. 31



TCRI PV  
**Shabby**  
p. 24

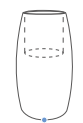

BFU PV  
**Bubble**  
p. 68



CILAR PV  
**Ardesia**  
p. 80



CLRG PV  
**City**  
p. 85



CNS PV  
**Tonda**  
p. 108

## Portvaso quadro | Square tall pot with insert



PIL PV  
**Shabby**  
p. 24



CUBLA PV  
**Ardesia**  
p. 79



CURG PV  
**City**  
p. 84

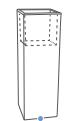

LTR PV  
**Quadra**  
p. 97

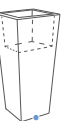

QNS PV  
**Quadra**  
p. 101

## Cassetta ovale | Oval planter



CSGU  
**Gaudi**  
p. 65



COVGL  
**Crespia**  
p. 120

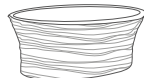

CASTOR  
**Country**  
p. 133

## Cassetta | Planter



CATRI  
**Shabby**  
p. 31

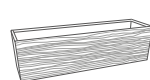

BASY  
**Shabby**  
p. 31



CASCORD  
**Bali**  
p. 59



CATLA  
**Ardesia**  
p. 78

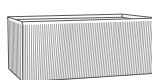

CSRG  
**City**  
p. 87

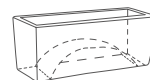

CATL XL  
**Quadra**  
p. 99

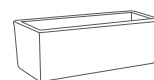

CATL B  
**Quadra**  
p. 97



BATL  
**Quadra**  
p. 99



Cassetta | Planter

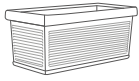

CRI  
**Lombardia**  
p. 128



CFE  
**Impero**  
p. 139



CAPOR  
**Agrigento**  
p. 145

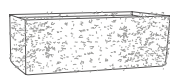

CASBOU  
**Bouclé**  
p. 46

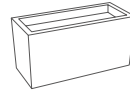

CASLINEA  
**Linea**  
p. 90

Cassetta alta | Tall planter



CASR PV  
**Shabby**  
p. 31



CATLR  
**Shabby**  
p. 31

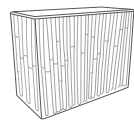

CANTL  
**Bambù**  
p. 38

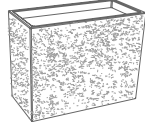

CASHBOU  
**Bouclé**  
p. 46

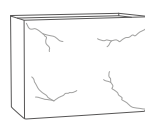

CATLH  
**Ardesia**  
p. 78

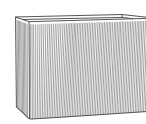

CSRGH  
**City**  
p. 87

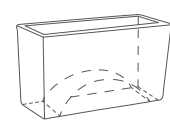

CATL  
**Quadra**  
p. 97

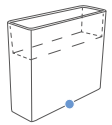

CSTS PV  
**Quadra**  
p. 103

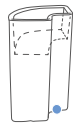

VNS PV  
**Quadra**  
p. 103

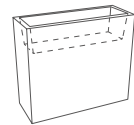

CASLINEA PV  
**Linea**  
p. 90

Cubo | Box

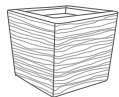

CUBRI  
**Shabby**  
p. 25

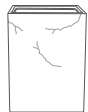

CUBLA  
**Ardesia**  
p. 79

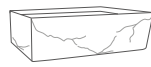

CUBLA B  
**Ardesia**  
p. 79

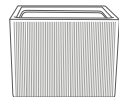

CURG  
**City**  
p. 87

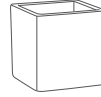

CUBL  
**Quadra**  
p. 97



QUPO  
**Agrigento**  
p. 145

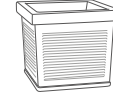

QUM  
**Lombardia**  
p. 128



QUCO  
**Impero**  
p. 139

Vaso a parete | Wall pot



VALPO  
**Tonda**  
p. 109



PFRI  
**Impero**  
p. 138



PMI  
**Lombardia**  
p. 128



VALMO  
**Tonda**  
p. 109

Vaso angolare | Corner pot

Vaso urbano | Urban pot



ACACORD  
**Bali**  
p. 57



ACAYA  
**Acaya**  
p. 73



ACASHAB  
**Shabby**  
p. 33

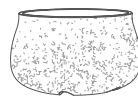

ACABOU  
**Bouclé**  
p. 46

Gerla a muro | Wall basket



GERSY  
**Shabby**  
p. 29



PFSA  
**Impero**  
p. 138

---

## Vaso pensile | Hanging basket



VPBSH  
**Shabby**  
p. 29



VPCL  
**Crespia**  
p. 121

---

## Orcio | Urn



VCSD  
**Leviga**  
p. 116

---

## Serbatoio acqua piovana | Rainbarrel



RAIN  
**Shabby**  
p. 28

## Colori linea Class

Class line colors

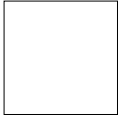

**BI**  
Bianco

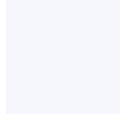

**NE**  
Neutro



**GH**  
Ghisa

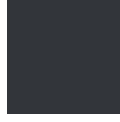

**I**  
Smoke



**PH**  
Graphite



**QZ**  
Quarzo



**71**  
Cool grey



**55**  
Industrial grey



**GD**  
Giada



**DW**  
Dark wood



**BW**  
Brown



**78**  
Tortora



**FA**  
Fango



**F1**  
Tufo



**67**  
Corda

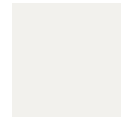

**77**  
Bianco perla



**46**  
Nomade



**97**  
Cipria



**OG**  
Oxford green



**99**  
Impruneta



**56**  
Senape



**95**  
Avio



**91**  
Polvere



**S3**  
Clay



**VV**  
Verde



**DE**  
Desert



**LV**  
Grigio lava



**B3**  
Carbon

## Texture linea Class

Class line textures



**Shabby**  
(67 - Corda)

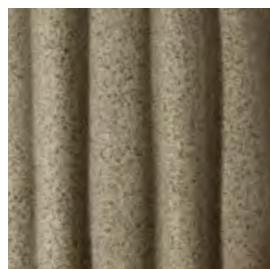

**Bambù**  
(OG - Oxford green)

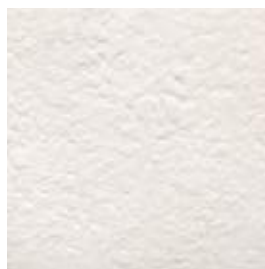

**Bouclé**  
(77 - Bianco perla)



**Trame**  
(67 - Corda)

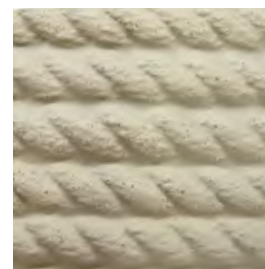

**Bali**  
(GD - Giada)



**Ardesia**  
(55 - Industrial grey)



**City**  
(46 - Nomade)



**Linea - Quadra - Tonda  
Leviga**  
(I - Smoke)



**Crespia**  
(78 - Tortora)

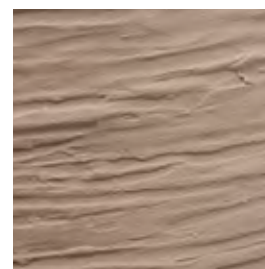

**Country**  
(78 - Tortora)



**Impero**  
(99 - Impruneta)



**Agrigento**  
(F1 - Tufo)

## Novità

News

Rimani sempre aggiornato sui nuovi colori e le nuove texture Vasar, inquadra il QR code per vedere se ci sono state modifiche

Stay up to date on Vasar new colors and new textures, scan the QR code to see if there have been any changes

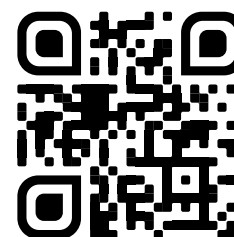

## Ingombri | Overall dimensions



**larghezza/  
diametro**  
width/  
diameter



**altezza**  
height



**capacità Lt**  
capacity Lt



**altezza  
portavaso**  
depth



**diametro  
portavaso**  
diameter

## Sottovasi | Saucers



**sottovaso**  
drainage  
saucer  
(fig.1)



**sottovaso  
con rialzo**  
saucer with  
elevation  
(fig.2)

## Specifiche tecniche | Technical specifications

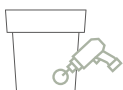

**fori  
predisposti**  
holes to be  
drilled  
(fig.3)

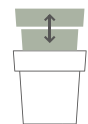

**contenitore  
estraibile**  
removable  
container  
(fig.4)



**portavaso con  
sottotappo**  
pot with  
insert and lid  
(fig.5)



**portavaso con  
sottotappo  
e sistema di  
drenaggio**  
pot with  
insert, lid and  
drainage system  
(fig.6)



**tappo a vite**  
screw cap  
(fig.7)



**rubinetto**  
tap  
(fig.8)



**zona piana per  
collegamento  
pluviale**  
flat area for  
rainwater  
connection  
(fig.9)

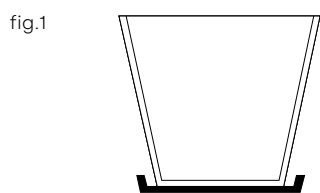

**sottovaso**  
drainage  
saucer

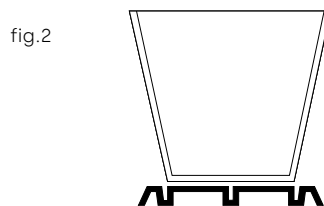

**sottovaso  
con rialzo**  
saucer with  
elevation

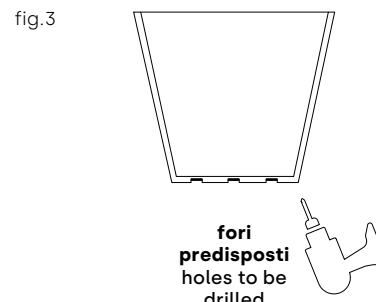

**fori  
predisposti**  
holes to be  
drilled

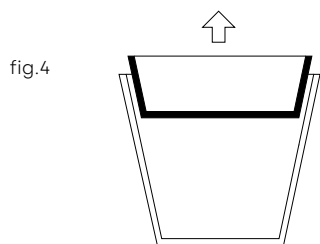

**contenitore  
estraibile**  
removable  
container

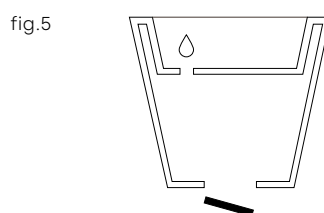

**portavaso con  
sottotappo**  
pot with  
insert and lid

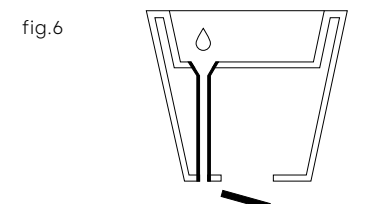

**portavaso con sottotappo  
e sistema di drenaggio**  
pot with insert,  
lid and drainage system

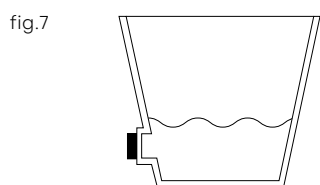

**tappo a vite**  
screw cap

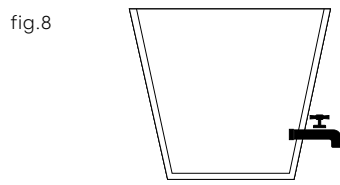

**rubinetto**  
tap

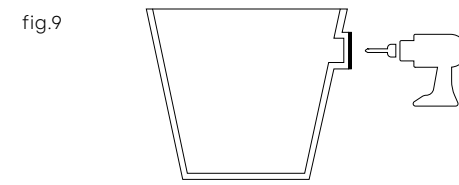

**zona piana per  
collegamento pluviale**  
flat area for rainwater  
connection

# Thanks to

Vogliamo ringraziare i luoghi e le persone che hanno reso possibile la realizzazione di questo catalogo:

We want to thank the places and people who have made possible the realization of this catalogue:

## Strutture

- Masseria Lamacoppa - Ostuni (BR);
- Masseria Santo Scalone - Ostuni (BR)
- Tenuta Parco Paolino - Ostuni (BR)
- Residenza Privata Trulli Amore - Ostuni (BR)
- WTH Studio - Ponte San Nicolò (PD)

## Vivai

- Pinto Nicola Florovivaistica – Locorotondo (BA)
- Floricoltura Cavinato di Cavinato Patrizia - San Giorgio delle Pertiche (PD)
- Floricoltura Briantea - Bellusco (MB)

## **Copyright © 2025**

### Art direction

Nui Design s.r.l.s.

### Graphic design

Nui Design s.r.l.s.

### Photos

Filippo Bamberghi

### Styling

Sissi Valassina

### Images (unsplash.com)

Aarn Giri - p. 2

Thomas Vogel - p. 10

Claudia Sommer - p. 16

Priscilla Fraire - Copertina

### Copywriting

Alessandro Rea

Tutti i diritti riservati.

È vietata ogni forma di utilizzo e riproduzione del materiale testuale, grafico e fotografico ivi contenuto.

**I dati e i colori riportati in questo catalogo sono indicativi.**

**Telcom si riserva il diritto di apportare eventuali variazioni o miglie a gli articoli illustrati senza preavviso.**

**I nostri uffici commerciali rimangono a vostra completa disposizione per qualsiasi ulteriore delucidazione.**

**Misure espresse in centimetri, tolleranza +/- 1.5 %.**

Information and colors in our catalogue are just indicative.

Telcom reserves the right to effect any changes or improvements to the illustrated articles, without notice.

For any further information our sales departments are at your complete disposal.

Measures are expressed in centimeters, tolerance +/- 1.5%.

**Telecom**<sup>®</sup>

---

**vašar**  
ITALIAN GARDEN DESIGN

modum

**Jolly**  
by Telecom

**AQUARIUS**<sup>®</sup>  
by Telecom  
SERBATOI PER ACQUA POTABILE

**eco**<sup>®</sup>  
**AQUARIUS**<sup>®</sup>  
PROGETTATI PER RISPETTARE L'AMBIENTE

**Buddy**<sup>®</sup>  
by Telecom

Le Giare

**Abruzzo**  
**Vasi**<sup>®</sup>  
by Telecom Group







Novità

**Telcom Spa**

via dell'Industria, 21  
72017 Ostuni (BR) Italy  
tel. +39 0831 348 111 r.a.  
fax +39 0831 304 510

telcom@telcomitalia.it  
telcom@legalmail.it

[www.telcomitalia.it](http://www.telcomitalia.it)

**Telcom**<sup>®</sup>